



DEPARTMENT OF THE ARMY
NEW ORLEANS DISTRICT, CORPS OF ENGINEERS
P. O. BOX 60267
NEW ORLEANS, LOUISIANA 70160-0267

October 20, 2014

REPLY TO
ATTENTION OF:

Operations Division
Regulatory Branch
Project Manager
Brian W. Breaux
(504) 862-1938

SUBJECT: MVN-2014-00754-MB

PUBLIC NOTICE

Interested parties are hereby notified that an application has been received by the District engineer for a Department of the Army permit to authorize the following pursuant to (X) Section 10 of the Rivers and Harbors Act of March 3, 1899 (30 Stat. 1151; 33 USC 403); and/or (X) Section 404 of the Clean Water Act (86 Stat. 816; 33 USC 1344).

GWM MITIGATION BANK – MADEWOOD TRACT IN ASSUMPTION PARISH

NAME OF APPLICANT: GWM, LLC, c/o Delta Resource Management, 36504 LA Hwy 30, Geismar, Louisiana 70734 ATTN: Dwayne Templet.

LOCATION OF WORK: The proposed project area is located in Sections 19, 20, 21, 22, 35, 36 & 38, Township 13 South, Range 15 East, near Napoleonville, in Assumption Parish, Louisiana. (Lat. 29.93833, Long. -90.97555)

CHARACTER OF WORK: The proposed bank property totals approximately 256.2 acres of existing agricultural fields and crawfish ponds. The applicant/sponsor proposes to restore 239.2 acres of bottomland hardwoods wetlands. Aspects of the proposed restoration plan include removing culverts and pumps, degrading levees and backfilling ditches to restore surface hydrology and planting of appropriate vegetation. A new ditch will be excavated to accommodate drainage of surrounding agricultural lands. Specific details of the proposed restoration plan can be found in the attached prospectus.

The comment period will close **30 days** from the date of this public notice advertisement. Written comments, including suggestions for modifications or objections to the proposed work, stating reasons therefore, are being solicited from anyone having interest in this permit request.

Letters must reference the applicant's name and the subject number, be addressed and mailed to the above address, ATTENTION: REGULATORY BRANCH.

The decision whether to issue a permit will be based on an evaluation of the probable impact including cumulative impacts of the proposed activity on the public interest. That decision will reflect the national concern for both protection and utilization of important resources. The benefit that reasonably may be expected to accrue from the proposal must be balanced against its reasonably foreseeable detriments. All factors which may be relevant to the proposal will be considered including the cumulative effects thereof; among those are conservation, economics, aesthetics, general environmental concerns, wetlands, historic properties, fish and wildlife values, flood hazards, floodplain values, land use, navigation, shoreline erosion and accretion, recreation, water supply and conservation, water quality, energy needs, safety, food and fiber production, mineral needs, consideration of property ownership and, in general, the needs and welfare of the people.

The Corps of Engineers is soliciting comments from the public; federal, state, and local agencies and officials; Indian Tribes; and other interested parties in order to consider and evaluate the impacts of this proposed activity. Any comments received will be considered by the Corps of Engineers to determine whether to issue, modify, condition or deny a permit for this proposal. To make this decision, comments are used to assess impacts on endangered species, historic properties, water quality, general environmental effects, and the other public interest factors listed above. Comments are used in the preparation of an Environmental Assessment and/or Environmental Impact Statement pursuant to the National Environmental Policy Act. Comments are also used to determine the need for a public hearing and to determine the overall public interest of the proposed activity.

No properties listed in the National Register of Historic Places are near the proposed work. The possibility exists that the proposed work may damage or destroy presently unknown archeological, scientific, pre-historical or historical sites or data. Copies of this notice are being sent to the State Archeologist and the State Historic Preservation Officer.

Our initial finding is that the proposed work would neither affect any species listed as endangered by the U.S. Department of Interior nor affect any habitat designated as critical to the survival and recovery of any endangered species.

This notice initiates the Essential Fish Habitat (EFH) consultation requirements of the Magnus-Stevens Fishery Conservation and Management Act. The applicant's proposal would result in the alteration of N/A acres of EFH utilized by various life stages of red drum and penaeid shrimp. Our initial determination is that the proposed action would not have a substantial adverse impact on EFH or federally managed fisheries in the Gulf of Mexico. Our final determination relative to project impacts and the need for mitigation measures is subject to review by and coordination with the National Marine Fisheries Service.

If the proposed work involves deposits of dredged or fill material into navigable waters, the evaluation of the probable impacts will include the application of guidelines established by the Administrator of the Environmental Protection Agency and certification that the proposed activity will not violate applicable water quality standards will be required from the Louisiana Department of Environmental Quality, Office of Water Resources, before a permit is issued.

Any person may request, in writing, within the comment period specified in this notice, that a public hearing be held to consider this application. Requests for public hearings shall state, with particularity, the reasons for holding a public hearing.

The applicant has certified that the proposed activity described in the application complies with and will be conducted in a manner that is consistent with the Louisiana Coastal Resources Program. The Department of the Army permit will not be issued unless the applicant received approval or a waiver of the Coastal Use Permit by the Department of Natural Resources.

You are requested to communicate the information contained in this notice to any other parties whom you deem likely to have interest in the matter.

Martin S. Mayer
Chief, Regulatory Branch

Prospectus

GWM Mitigation Bank Madewood Tract Assumption Parish, Louisiana

September 18, 2014

PREPARED FOR:

U.S. Army Corps of Engineers, New Orleans District

Sponsor:

GWM, LLC
919 Sweets Lane
Baton Rouge, LA 70808

Agent:

Delta Resource Management, LLC
36504 Hwy 30
Geismar, LA 70734

Table of Contents

1.0	INTRODUCTION	1
1.1	Owner and Bank Sponsor.....	1
1.2	Site Location	1
1.3	Driving Directions to the Site.....	1
2.0	PROJECT GOALS AND OBJECTIVES	2
3.0	ECOLOGICAL SUITABILITY OF THE SITE.....	3
3.1	Historical Ecological Characteristics of the Site.....	3
3.2	Current Ecological Characteristics of the Site	3
3.2.1	Soils.....	4
3.2.2	Vegetation.....	5
3.2.3	Hydrology	5
3.2.4	NRCS Wetland Determination and CEMVN Jurisdictional Determination.....	6
3.3	General Need for the Project in this Region	6
3.4	Technical Feasibility	6
4.0	ESTABLISHMENT OF THE MITIGATION BANK	7
4.1	Site Hydrology Restoration.....	7
4.2	Drainage Area	8
4.3	Vegetative Restoration	8
4.4	Invasive Species	8
4.5	Monitoring.....	9
4.6	Current Site Risks.....	9
4.7	Easements and Encumbrances	9
4.8	Long-Term Sustainability of the Site.....	9
5.0	PROPOSED SERVICE AREA.....	9
6.0	OPERATION OF THE MITIGATION BANK.....	10
6.1	Project Representatives	10
6.2	Qualifications of the Sponsor and Agent	10
6.3	Proposed Long-Term Ownership and Management Representatives	11
6.4	Site Protection	11
6.5	Long-Term Strategy	11
7.0	CONCLUSION.....	11
8.0	REFERENCES	12

FIGURES

Figure 1	Location Map
Figure 2	Site Map
Figure 3	Service Area Map
Figure 4	Existing Conditions Map
Figure 5	Existing Elevations Map Restoration Plan
Figure 6	Soils Map
Figure 7	Proposed Mitigation Plan Map
Figure 8	Watershed Map
Figure 9	Proposed Hydrology Restoration Map
Figure 10	Post-Restoration Map

Table of Contents

APPENDICES

- Appendix A Historical USGS Topographic Maps**
- Appendix B CEMVN Jurisdictional Determination & NRCS Wetland Determination**
- Appendix C Hydrology Restoration Drawings**

1.0 INTRODUCTION

Delta Resource Management, LLC (DRM) submits this Prospectus to the U.S. Army Corps of Engineers, New Orleans District (CEMVN), Louisiana Department of Natural Resources (LA DNR) and Interagency Review Team (IRT) to initiate evaluation of the proposed GWM Mitigation Bank - Madewood Tract (hereinafter Bank) in accordance with 33 CFR § 332.8(d)(2). The 256.2-acre Bank will provide compensatory mitigation for unavoidable, permitted impacts to “Waters of the United States” if deemed appropriate per 33 CFR § 332.3 (1)(a) and 33 CFR § 332.3 (1)(b)3. The details pertaining to the use of this site as a mitigation bank will be specified in the subsequent Mitigation Banking Instrument (MBI).

1.1 Owner and Bank Sponsor

The Bank lands are owned in fee title by Madewood Incorporated. Glenwood Inc., Woodlawn Farm Land, LLC and Madewood Incorporated have collectively formed GWM, LLC (GWM) to serve as the Bank Sponsor for the GWM Mitigation Bank - Madewood Tract. GWM will oversee construction and establishment of the Bank and will serve as the long-term manager and steward. GWM may appoint a long-term steward pursuant to 33 CFR 332.7 (d) and subject to approval by CEMVN. The anticipated long-term management will consist of monitoring, invasive species control, boundary maintenance and forest management. The site will be protected by a perpetual conservation servitude which is described in Section 6.4.

Mail correspondence with the Sponsor may be directed to Dwayne Templet at the following address (Delta Resource Management, LLC, 36504 Hwy 30, Geismar, LA 70734). Electronic correspondence with the Sponsor should be e-mailed to dptemplet@eatel.net. Mr. Templet can be contacted by phone at 225-715-5733.

1.2 Site Location

The proposed Bank is located near the town of Napoleonville, Assumption Parish, Louisiana, approximately 1 mile east-northeast of the Elm Hall Wildlife Management Area on the east bank of Bayou Lafourche (Figures 1 and 2). The Madewood tract is within the East Central Louisiana Coastal Watershed, USGS Cataloging Unit 08090301 and LA DNR’s Barataria Basin (Figure 3). The specific site latitude/longitude and Section, Township and Range information for the tract is below:

Table 1. Bank Location Data by Tract

	Latitude	Longitude	Section(s)	Township	Range
Madewood	29° 56’ 18”N	90° 58’ 32”W	19, 20, 21, 22, 35, 36, 37, &38	13S	15E

1.3 Driving Directions to the Site

From I-10 (Sorrento exit 182), take LA 22 south for 0.3 miles to LA 70. Turn left on LA 70 and continue south 17.2 miles to LA 70 spur. Turn left onto LA 70 spur and proceed 1.5 miles south to LA 308 near Paincourtville. Take a left on LA 308 and proceed east-southeast for 6.2 miles to the intersection of LA 308 and Madewood Road. Take a left on Madewood Road proceed east approximately 1.5 miles to the tract.

2.0 PROJECT GOALS AND OBJECTIVES

The goal of the Bank is the restoration through re-establishment and rehabilitation of bottomland hardwood coastal forested habitat in HUC 08090301. The Natural Resource Conservation Service is preparing a wetland determination. Present habitat types found within the proposed Bank are all anticipated to be Prior Converted Cropland (PC) with intermixed non-wetlands (roads and levees). Current habitat types within the restoration tract are displayed in Figure 4. Table 2 summarizes the current habitat and proposed mitigation types/acreage.

Table 2. Existing Habitat Types and Proposed Mitigation Types/Acres

Existing Habitat Type	Proposed Habitat Type	Mitigation Type	Acres
Cropland	Bottomland Hardwood	Re-establishment	163.5
Levee/Road	Bottomland Hardwood	Re-establishment	10.9
Subtotal (174.4)			
Cropland	Bottomland Hardwood	Rehabilitation	1.2
Crawfish Pond	Bottomland Hardwood	Rehabilitation	61.4
Ditch	Bottomland Hardwood	Rehabilitation	2.2
Subtotal (64.8)			
Total Mitigation Acres			239.2
Cropland	Ditch	Non-mitigation	0.3
Ditch	Ditch	Non-mitigation	4.5
Levee/Road	Trail	Non-mitigation	0.4
Total Non-Mitigation Acres			5.2
Total Conservation Servitude Acres			244.4
ROW	ROW	Existing ROW/servitude	11.8
Total Tract Acres			256.2

The specific project goals and objectives are to re-establish and protect the physical, chemical and biological functions of a coastal bottomland hardwood forested wetland ecosystem as follows:

- Re-establish historic and self-sustaining hydrology by removing ditching, culverts, levees and backfilling artificial drainages where possible;
- improve water quality and reduce non-point source pollution, sedimentation, nutrient loading, and chemical runoff (e.g., fertilizer and herbicides) within a coastal watershed through the retirement of intensive agricultural use;
- restore approximately 239.2 acres of native bottomland hardwood habitat through afforestation with native species benefitting resident wildlife populations and neotropical migratory bird species;
- ensure long-term viability and sustainability by implementing specific management strategies such as (1) active and adaptive management, (2) establishment of financial assurances (i.e., construction, establishment) and long term funding mechanisms, (3)

- initial, intermediate, and long-term monitoring, (4) initial, intermediate, and long-term maintenance, and (5) initial, intermediate, and long-term invasive species control; and
- Establish long-term protection through the execution of a perpetual-term conservation servitude and establishment of a long-term fund to cover annual expenditures associated with maintenance and management of the Bank.

3.0 ECOLOGICAL SUITABILITY OF THE SITE

3.1 Historical Ecological Characteristics of the Site

The Bank is located within the approximate 25 million-acre Lower Mississippi Alluvial Valley (LMAV). Prior to settlement and colonization, the LMAV consisted of mostly contiguous bottomland hardwoods and swamps. Significant deforestation began after colonization by Europeans due to the need to convert these lands to agricultural uses and satisfy a growing demand for timber. The rate of deforestation increased in the 20th Century due to major flood control projects particularly with major levee construction on the Mississippi River following the passage of the 1928 Flood Control Act. Advancements in land clearing technology and inflation in the price of agricultural commodities, namely soybeans, during the 1960s and 1970s resulted in an acceleration of the deforestation in the LMAV. By the mid-1980s, only 20 percent or approximately 6.6 million acres of the LMAV remained forested, with much of it in fragmented blocks.

The primary sources of hydrology on the Bank were historically overbank flooding from Bayou LaFourche, Atchafalaya, and Mississippi River systems, precipitation and high water tables. Overbank flooding is no longer a major driver of hydrology in the region with extensive leveeing of the Mississippi and Atchafalaya river systems. Bayou Lafourche, a former tributary of the Mississippi River, was leveed in 1904 at its source, the Mississippi River near Donaldsonville. Prior to the levee is estimated that Bayou Lafourche carried roughly 12 percent (over 40,000 cubic feet per second) of Mississippi River flow. In 1954, a pumping station was built at Donaldsonville to allow water to enter Bayou Lafourche. Now only 200 cubic feet per second of Mississippi River flow is allowed down Bayou Lafourche. The primary sources of hydrology in the Bank areas today are precipitation, surface runoff from higher elevations, backwater flooding and high water tables near the surface. The tracts comprising the Bank historically contained mixed deciduous bottomland hardwood habitat underlain with hydric soils. Examination of the 1955 Thibodaux USGS historical topographic map (Appendix A) indicates that the Madewood Tract was cleared and in agricultural production since at least 1955. Anecdotal data from the landowners is that agricultural lands in production today were cleared in the late 1800's. A review of the 1892 Thibodaux USGS historical topographic map documents land clearing and agricultural production along Bayou Lafourche in the vicinity of the tract as early as 1892.

3.2 Current Ecological Characteristics of the Site

The project area primarily consists of crawfish ponds, agricultural fields and supporting infrastructure (e.g. roads, levees, ditches). Although crawfish ponds and agricultural fields dominate the project area and adjacent farmed properties, contiguous mature bottomland hardwood forests greater than 500 acres in size exist along the eastern perimeter of the Madewood

tract. Elevations in the area range from lows of less than 2 ft. within the ponds and ditch bottoms to over 7 ft. within the agricultural fields (Figure 5).

3.2.1 Soils

The soils found on the Bank consists primarily of clays and loams commonly found in floodplains adjacent to natural levees (Figure 6). Typical drainage patterns have been altered to accommodate agricultural operations on the tracts. The soils mapped within the Bank are summarized below:

Soil Types - Madewood Tract	Acres	% of Tract
Water (W), former Schriever clay - inundated, hydric	5.4	2.1%
Schriever clay, frequently flooded (Sm) - poorly drained, hydric	57.6	22.5%
Schriever clay (SkA) - poorly drained, hydric	121.6	47.5%
Thibaut clay (TbA) - poorly drained, hydric	26.4	10.3%
Cancienne silt loam (CmA) - somewhat poorly drained	45.2	17.6%
Total	256.2	100%

On April 2, 3 and July 24, 2014, DRM conducted soil observations at two data points and seven soil sample locations (see Figure 6) to support the wetland delineation on the proposed Bank, as summarized below. All data plots and six of the seven soil sample points had sufficient hydric soil indicators to be considered hydric according to U.S. Army Corps of Engineers criteria (USACE 1987 and 2010). The one non-hydric soil sample was in a very well-drained portion of field adjacent to an agricultural drain. The hydric soil indicators included depleted below dark surface (A11) and depleted matrix (F3).

Data Point	Soils	Dominant Vegetation	Hydrology Indicators	Determination
P1	*No soils data (permanently flooded) See P2 (below)	Alligator weed & cattail dominant.	Surface water (12-18"), high water table, soil saturation in upper 12 inches & aquatic fauna	Other Waters
P2	7-16" clay (Hydric) 10YR 3/1 10YR 3/3 (15%)	Soft rush, cutgrass & lizard's tail dominant. Butterweed and sedges	Surface water (0-1"), high water table, soil saturation in upper 12 inches, sediment deposits & drift deposits.	Wetland
SS1	8-12" - clay (Hydric) 10YR 4/2 10YR 4/4 mottles (30-35%)	Soybeans	NA-well drained & actively farmed agricultural field	Non-wetland
SS2	8-12" – silty clay loam (Hydric) 10YR 5/2 10YR 5/3 & 5/4 mottles (45-50%)	Soybeans	NA-well drained & actively farmed agricultural field	Non-wetland
SS3	8-12" – clay loam (Hydric) 10YR 4/1 10YR 5/6 (~25%)	Soybeans	NA-well drained & actively farmed agricultural field	Non-wetland
SS4	8-12" – clay loam (Hydric) 10YR 4/2 10YR 4/4 mottles (40-45%)	Soybeans	NA-well drained & actively farmed agricultural field	Non-wetland
SS5	8-12" - silty clay loam (Non-hydric) 10YR 5/3 10YR 5/4 mottles (45%)	Soybeans	NA-well drained & actively farmed agricultural field	Non-wetland
SS6	8-12" – silty clay loam (Hydric) 10YR 5/2 10YR 5/4 & 5/6 mottles (~45%)	Soybeans	NA-well drained & actively farmed agricultural field	Non-wetland
SS7	8-12" - clay loam (Hydric) 10YR 4/2 10YR 4/3&4/4 mottles (40-45%)	Sugarcane	NA-well drained & actively farmed agricultural field	Non-wetland

3.2.2 Vegetation

The Bank areas are currently in sugarcane and crawfish ponds with some fallow aquaculture ponds (see Figure 4). Historically, soybeans and sugarcane have been the predominant crop when the fields have been in production. The active ponds are predominantly open water. There is some vegetation present including alligator weed (*Alternanthera philoxeroides*), cattail (*Typha domingensis*) and various sedges (*Carex* sp.).

Typical herbaceous vegetation within the non-wetland fallow agricultural/crawfish ponds include goldenrod (*Solidago* sp), giant ragweed (*Ambrosia trifida*), blue vervain (*Verbena hastata*), curly dock (*Rumex crispus*), annual bluegrass (*Poa annua*), spiny sowthistle (*Sonchus asper*), Johnsongrass (*Sorghum halapense*), oxalis (*Oxalis* sp.), buttercup (*Ranunculus* sp.), dewberry (*Rubus trivialis*) and geranium (*Geranium* sp.) Common shrubs and shrubs in the herbaceous layer include swamp dogwood (*Cornus drummondii*), boxelder (*Acer negundo*), sugarberry (*Celtis laevigata*) and winter willow (*Baccharis halimifolia*). Woody vines include dewberry (*Rubus trivialis*) and pepper-vine (*Ampelopsis arborea*).

In the potential wetland fallow agriculture fields/crawfish ponds, dominant vegetation includes cattail, soft rush (*Juncus effusus*), sedges, cutgrass (*Leersia hexandra*), lizard's tail (*Saururus cernuus*), butterweed (*Packera glabella*), blackberry (*Rubus argutus*) and trumpet creeper (*Campsis radicans*). Common shrubs include red maple (*Acer rubrum*), black willow (*Salix nigra*) and green ash (*Fraxinus pennsylvanica*).

3.2.3 Hydrology

Current primary hydrology sources to the Bank are direct precipitation, high water tables and occasional backwater flooding from the adjacent forested BLH wetlands and connected swamp systems tied Lac des Allemands. The average annual precipitation in Napoleonville is approximately 59.7 inches. June is the wettest month of the year with an average precipitation of 6.9 inches and November is the driest month of the year with an average precipitation of 4.2 inches.

The Madewood tract has significant hydrology modifications including levees and ponds for crawfish production and traditional agricultural drainage improvements associated with soybean and sugarcane production (e.g. perimeter drains, cross ditches, and culverts). Elevations in the area range from below 2 feet in the ponds and drains in the easternmost portions of the site to just over 7 feet in the western portions (see Figure 5). Artificial influences include the pumping of ground water for agricultural purposes (i.e. irrigation for crawfish production). A natural ridge is within the center of the site. Hydrology flow is to the north and south-southeast from this central ridge area. Madewood Canal is a primary drain along the south boundary that is shared with the adjacent landowner. This drainage supports agriculture production offsite to the southwest and must be retained. A second primary drain is located along the northern portion of the tract and shared with the adjacent landowner. The two primary drains convey water northeast from the site to Baker Canal North (the major drainage feature in the area of the Madewood tract). General water flow from the tract is east-northeast through the adjacent bottomland hardwood and baldcypress swamp forests to Baker Canal North, thence southeast to Baker Canal East, Bayou Citamon, Bayou Chevreuil, and Grand Bayou systems eventually connecting to the Lac des

Allemands system. The eastern end of the Bank and the primary drains connected to Baker Canal receive tidal flows and backwater floodwaters through these systems.

3.2.4 NRCS Wetland Determination and CEMVN Jurisdictional Determination

The National Resource Conservation Service (NRCS) issued a wetland determination in June 2014 (Appendix B). NRCS classified portions of the Bank site with a “crop history” as either Prior Converted (PC), Prior Converted/Non-Wetland (PC/NW) or Non-Wetland (NW). The CEMVN issued a preliminary jurisdictional determination on September 9, 2014 (MVN-2014-01186-SE). A copy of the CEMVN jurisdiction determination is in Appendix B.

3.3 General Need for the Project in the Region

The East Central Louisiana Coastal Watershed (HUC 08090301) contains over 1.5 million acres of diverse habitat ranging from development and infrastructure to farmland, bottomland hardwoods, river systems, bayous, swamps, and backwater lakes. The upper limits of the East Louisiana Coastal Watershed begins at the junction of Bayou Lafourche and the Mississippi River near Donaldsonville, Louisiana. The western limits extend south along Bayou LaFourche (east boundary of the West Central Louisiana Coastal Watershed) over 105 miles to the Gulf of Mexico. The eastern limits extend from the junction of Bayou Lafourche and the west bank of the Mississippi River south to the Gulf of Mexico. The watershed covers parts of eight parishes including Iberville, Ascension, Assumption, St. James, St. Mary, Terrebonne, St. Charles and Plaquemines. The bank is within LA DNR’s Office of Coastal Management (OCM) recognized Barataria Basin.

There is one approved mitigation banks located within Barataria Basin as of the date of this report (Enterprise Woodlands Mitigation Bank). There are two mitigation banks within HUC 08090301 with available forested wetland credits (Paradis Mitigation Bank and Enterprise Woodlands Mitigation Bank (Coastal and Non-coastal). The availability of forested wetland credits is limited at the time of this report. Please refer to the Federal Regulatory In-lieu Fee and Bank Information Tracking System (RIBITS) database for current data. In summary, the proposed Bank would be of great to service to commercial, residential, industrial and utility/transmission/pipeline projects within or crossing through HUC 08090301 and LA DNR’s Barataria Basin.

3.4 Technical Feasibility

The existence of directly adjacent bottomland hardwood forested wetlands connected to each proposed restoration tract is the most directly evidence of the feasibility of the proposed restoration. There are also vast bottomland hardwood and baldcypress forested ecosystems at comparable elevations in the Lac des Allemands swamp system within HUC 08090301. Technically, the construction work required to develop the restoration tract consists of routine and feasible site restoration and forestry practices. The proposed construction will consist of site preparation, back filling of artificial drains, removal of culverts/artificial drainage or impoundment features, re-establishment of historic drainage patterns, invasive species control and hardwood planting. The existing hydric soils and relatively flat landscape imply that planned site preparation, minimal land leveling and earthwork will be required to successfully restore wetland hydrology and a bottomland hardwood forested system. Combined, these factors are indicators that the proposed restoration of the Bank areas to productive bottomland hardwood forested wetlands should be biologically and technically feasible.

4.0 ESTABLISHMENT OF THE MITIGATION BANK

Site restoration will be accomplished through hydrology restoration and replanting (afforestation) to the native bottomland hardwood forested wetland habitat that existing before conversion for agricultural uses. There will be a natural progression from the cessation of farming to the filling/rerouting of artificial drains and agricultural ditches, degradation of levees, removal of culverts, pumps and other artificial drainage features, restoration of natural surface topography, site preparation, the elimination of invasive species, and the replanting of bottomland hardwood and baldcypress species. The work plan for the Bank will incorporate a watershed approach. Improvements to factors that impede water movement (e.g. degrading of pond levees, removal of culverts, etc.) are intended to increase aquatic functions and values on the site and surrounding area. Afforestation will naturally improve physical factors that slow water movement and increase nutrient retention. The reestablishment and rehabilitation of forested wetlands on the Bank will create physical structure (native grass, brush, shrubs, and eventually trees) that will slow the movement of surface runoff across the property during heavy rain events. Slower water movement leads to longer periods of water retention and contact with vegetation, which results in lower levels of suspended solids and dissolved solids, and higher nutrient and sediment filtration rates. Overtime, a more natural hydrology regime will return to the Bank.

4.1 Site Hydrology Restoration

The primary sources of hydrology to the proposed bank will be direct precipitation, high water tables, tidal ebb and flow from connected tidal systems and occasional backwater flooding from the adjacent forested wetlands. The general watershed of the Bank is depicted in Figure 8. Rainfall is estimated to be over 57 inches per year (NRCS 2013). The existing improved and diverted water flow prevents ponding and saturation within the upper portions of the soil horizon. As part of the restoration process, the interior and cross-ditches currently in place to drain the Bank will be removed or modified. Two of the major surface drains that convey water from the agricultural areas to the west of the Bank will be retained to continue farming operations. All hydrology connections in the Bank to the drains to remain will be filled or plugged. The drains to remain connect offsite to the east to Baker Canal systems and thence east-southeast to tributaries and swamps systems connected to Lac des Allemands. In general, reverse hydrology flows will occur in the drains to remain and connected forested wetlands along the eastern edge of the Bank with backwater flood events and tidal fluctuations.

The agricultural turn-rows, trails, spoil banks and other areas of unnatural high ground across the Bank will be degraded and deposited in adjacent fields, agricultural drains, ponds or in non-wetlands to restore natural elevation. All onsite culverts located within the drainage ditches will be plugged or removed. All pond levees will be degraded to restore natural elevations. Approximately 10.9 acres of levees and spoil banks will be degraded to fill approximately 63.6 acres of ponds and agricultural ditches onsite.

These measures will restore historic west to east surface flows across the Bank. Figure 9 depicts the location of levees to degrade, ditches to fill/reroute or remain, culverts to be plugged or removed and other drainage features to be modified. Post restoration flows are depicted in Figure 10. Cross-sections depicting existing and post-restoration grades/profiles are contained in Appendix C. The proposed modification of existing internal drainage features combined with the

slow infiltration and low permeability of the site's heavy clay soils will help to re-establish wetland hydrology throughout the Bank.

4.2 Drainage Area

The limit of the drainage area associated with the Bank is not projected to change (see Figure 8); however post-restoration sheet flow, inundation levels, and soil saturation levels will be altered to restore wetland hydrology. The restoration tract has ditching and drainage features within that convey water from agricultural areas (generally at higher elevations) through the Bank to adjacent bottomland hardwood forested systems (generally at lower elevations). The locations of these drains are summarized in Figures 5 and 9. While some onsite drainage will remain, most post-project surface flows that are currently directed to and contained within drains, will be allowed to cross the Bank via sheet flow (see Figure 10). The hydrology restoration will lead to increased saturation and inundation rates, helping to restore historic hydrologic conditions.

4.3 Vegetative Restoration

The proposed restoration tract contains farmed PC/farmed wetlands and non-wetlands proposed for bottomland hardwood re-establishment and rehabilitation. Afforestation efforts will utilize an appropriate combination of hard and soft mast producing bare-root stock in all plantings. The specific breakdown of each assemblage to be planted will be representative of those historically common to bottomland hardwood habitat of the Lac Des Allemands system. These species assemblages are identified in *The Natural Communities of Louisiana* (LNHP 2009). These assemblages and their planting locations will be stated in the subsequent Draft MBI. Planting densities, planting success rates, escrow or bond sum release rates and monitoring requirements will be consistent with other recently implemented CEMVN approved mitigation banks. Soils in the fields within the project area will be mechanically prepared for vegetative plantings. Disking and deep-ripping may be used to alleviate soil compaction and encourage air and water pore space for seedling establishment and proper root growth.

The Madewood restoration tract will re-establish 174.4 acres of bottomland hardwood habitat and rehabilitate 64.8 acres of bottomland hardwood habitat (total of 239.2 acres of restored forested bottomland hardwood habitat). One interior access trail (0.4 acres) will be retained as upland habitat (non-mitigation). Two drains (4.8 acres) will be maintained as non-mitigation within the Bank boundaries. There are an estimated 11.8 acres of utility and pipeline rights-of-way that will be within the Banks's boundaries but excluded from the Conservation Servitude (see Figure 7).

4.4 Invasive Species

Invasive plant species, such as the Chinese tallow tree (*Triadica sebifera*) growing within and near the restoration areas, will be removed by mechanical or chemical prior to initial planting and as needed thereafter to remain in compliance with the MBI seedling survival and invasive species control standards. The percent cover of invasive plants will be monitored during short-term and long-term success monitoring.

4.5 Monitoring

At minimum, monitoring reports shall be completed in the spring (when new growth makes identification practicable) of Years 1, 3, 5, 10, 15, and prior to and following the first thinning operation. Reports will be submitted to CEMVN by December 31 of each monitoring year.

4.6 Current Site Risks

The Bank is located in a rural area surrounded by compatible land uses dominated by agriculture and timber land (existing BLH and baldcypress swamp forested wetlands). The Sponsor does not foresee any risks or long-term adverse impacts to the Bank resulting from the continued existence and operation of adjacent land uses. There are no existing hydrological disturbances (actively pumped systems) within or adjacent to the restoration tracts that the Sponsor or Owner do not directly control. Current adjacent land uses and management will not affect the establishment and long-term success of the proposed Bank.

4.7 Easements and Encumbrances

There are no mortgages on the proposed Bank. There are existing utility rights-of-way and pipeline servitudes. The Bank is not located within any designated spillway or floodway and therefore is not expected to be encumbered by any flowage or other environmental easements. All existing encumbrances will be excluded from the Bank's Conservation Servitude. A land survey and title opinion will be performed for verification and to ensure exclusion. The survey and title opinion will be included in the draft MBI.

4.8 Long-Term Sustainability of the Site

Passive hydrology restoration measures are proposed for the Bank. Long-term viability and sustainability of the Bank will be ensured through active and adaptive forest planning and management including, but not limited to appropriate monitoring, invasive species control and long-term maintenance.

Louisiana Civil Code, Article 490, treats water resources under the theory of absolute ownership and rule of capture, provided that capture does not result in harm to neighbors. The Bank's hydrology restoration will depend primarily on precipitation supplemented by high water table and potential backwater flooding/high flow events from adjacent forested systems and connected tributaries. All interior culverts and pond levees are proposed to be removed. Should it be deemed necessary to retain any features, they would be passively maintained unless hydrologic monitoring reports reveal a need for maintenance. Should this occur, appropriate coordination will be performed with IRT and approval obtained. The Sponsor does not foresee any capture or use of irrigation/well water; subsequently no adverse impacts to neighboring properties are anticipated as a result of this project.

5.0 PROPOSED SERVICE AREA

The Madewood tract is within the East Central Louisiana Coastal Watershed, HUC 08090301 (see Figure 3). GWM proposes HUC 08090301 as the Primary Service Area for restoration on the Madewood Tract. This watershed contains portions of Ascension Parish, Assumption Parish, St. James Parish, St. John the Baptist Parish, St. Charles Parish, Jefferson Parish, Lafourche Parish and Plaquemines Parish. Use beyond the bank's primary service area will be determined by the CEMVN on a case-by-case basis.

6.0 OPERATION OF THE MITIGATION BANK

The Sponsor will comply with all conditions required of a mitigation bank sponsor by the CEMVN. The Bank will be established and operated through mitigation bank procedures outlined in 33 CFR § 332.8. This includes, but is not limited to, review process, modifications, permit coordination, project implementation, financial assurance determination and mechanisms, credit determination, accounting procedures, credit withdrawals, and the use of credits. Details on the operation of the Bank will be further described in the Draft MBI per 33 CFR § 332.8(6).

6.1 Project Representatives

Sponsor: GWM, LLC
919 Sweets Lane
Baton Rouge, LA 70808
Attn: James H. Boyce, Jr.

Agent: Delta Resource Management, LLC
36504 Hwy 30
Geismar, LA 70734
dptemptlet@eatel.net
225-715-5733

Landowner: Madewood Incorporated
4543 Hwy. 308
Napoleonville, LA 70390

6.2 Qualifications of the Sponsor and Agent

GWM, LLC (GWM) will be responsible for Bank land management and administration. GWM is an entity comprised collectively of the fee owners of Glenwood, Inc., Woodlawn Farm Land, LLC and Madewood Incorporated. GWM is the Sponsor of proposed GWM Mitigation Banks on the Glenwood, Woodlawn and Madewood Tracts, each with separate Prospectus documents. All fee owners and their families have ownership interests in the land dating back to the early 1900's. The fee owners also enjoy recreational opportunities on the property and have a vested interest in the success of each Bank. Mr. James H. Boyce, Jr. is the Authorized Agent and Manager for GWM. Mr. Joseph "Will" Thibaut is an owner and farm manager for Glenwood, Inc., Woodlawn Farm Land, LLC and Madewood Incorporated. He has been involved with the farming and historic aquaculture operations since the 1970's. He currently oversees the farming and daily operations of all three tracts. Mr. James H. Boyce, Jr. is a majority owner of Woodlawn Farm Land, LLC and Madewood Incorporated. He has been indirectly involved with the agriculture production on all three tracts since the early 1970's. Mr. Boyce is also the Authorized Agent and Manager for the owners of Timberton Wetlands Mitigation Bank in Ascension Parish, LA (712.4 acres).

Mr. Dwayne Templet is the lead project manager and agent for the Sponsor. Mr. Templet is a senior forester and wetland scientist with over 23 years of experience in natural resource management including wetlands, wildlife and forest management. This experience includes the development of Timberton Wetlands Mitigation Bank (712.4 acres) and permittee responsible mitigation preservation projects totaling 2,241 acres and 4,960 acres in Ascension and St. James Parish. Mr. Templet has also performed/supervised site preparation, monitoring and management

related services for multiple permittee responsible mitigation projects and six approved banks including, Calcasieu Mitigation Bank, Bayou Teche Mitigation Bank, Zachary Mitigation Bank - Redwood Creek Site, Spanish Lake, Timberton Wetlands Mitigation Bank and Mossy Hill Mitigation Bank.

6.3 Proposed Long-Term Ownership and Management Representatives

Madewood, Incorporated will continue as the long-term owner of the Bank lands. GWM will serve as the Sponsor, long-term manager, and steward of the Bank. Mr. Boyce will be the Sponsor's manager. Mr. Templet will serve as the Sponsor's forester and wetland scientist. The Sponsor will reserve the option of appointing a long-term steward in accordance with 33 CFR 332.7(d) (1). The appointment of long-term steward shall be approved by the CEMVN. The anticipated long-term management will consist of monitoring, invasive species control, forest management, boundary maintenance and site protection.

6.4 Site Protection

The Sponsor (or Long-term Steward) / Owners, or any heirs, assigns or purchasers shall be responsible for protecting lands contained within the mitigation area in perpetuity. In order to provide for such protection, the Owner shall execute a perpetual conservation servitude (pursuant to the Louisiana Conservation Servitude Act, R.S. 9:1271 et seq.) on all acreage identified as the Bank and record it in the Mortgage and Conveyances Records Office of Assumption Parish. The conservation servitude will be held by a qualified, conservation-oriented 501(c)(3) organization whose mission is to retain or protect the land's natural habitat, open space, scenic, educational, recreational, historical, or cultural values. The servitude will prohibit activities such as cattle grazing, clear cutting, fill discharges, or other commercial surface development that would diminish the quality or quantity of restored forested wetlands.

6.5 Long-Term Strategy

In order to fund long-term maintenance of the site, GWM will provide financial assurances, which shall generate funds in order to implement long-term maintenance and management. The details of the funding mechanism and arrangements shall be established within the MBI. The site shall be constructed to be self-sustaining with management activities limited primarily to items such as inspections, invasive species control and boundary maintenance. The Sponsor will ensure the long-term success and sustainability of the Bank through mechanisms including vegetative and hydrologic maintenance as necessary, site monitoring, invasive species management, establishment of financial assurances, and protection in perpetuity by conservation servitude. A long-term management plan will be included in the MBI that will include long-term management needs, costs and identify a funding mechanism in accordance with 33 CFR 332.7(d).

7.0 CONCLUSION

In summary, the proposed Bank has a high potential for successfully restoring over 239 acres of bottomland hardwood forested wetlands in the East Central Louisiana Coastal Watershed and Barataria Basin. The cessation of agricultural land use, restoration of natural hydrology, and rehabilitation/re-establishment of forested wetland habitat will improve watershed quality by reducing non-point source runoff. The expansion of forested wetland habitat will promote ecosystem plant diversity and increase habitat for resident and migratory wildlife species in the region.

8.0 REFERENCES

- Allen, J.A., B.D. Keeland, J.A. Stanturf, A.F. Clewell, and H.E. Kennedy (2001 [rev. 2004]). A guide to bottomland hardwood restoration: US Geological Survey, Biological Resources Division Information and Technology Report USGS/BRD/ITR-2000-0011. USDA Forest Service, Southern Forest Research Station, General Technical Report SRS-40, 132 pp.
- Coastal Wetland Forest Science Working Group (2005) Conservation, Protection and Utilization of Louisiana's Coastal Wetland Forests. A final report to the Governor of Louisiana from the Coastal Wetland Forest Science Working Group. April 30, 2005. 102 pp.
- Cowardin, L.M., V. Carter, F.C. Golet, and E.T. LaRoe (1979) Classification of wetlands and deepwater habitats of the United States. U.S. Fish and Wildlife Service, Office of Biological Services, FWS/OBS-79/31, Washington, DC.
- Gardiner, E.S. and J.M. Oliver (2005) Restoration of bottomland hardwood forest in the Lower Mississippi Alluvial Valley In: Restoration of boreal and temperate forests in the Lower Mississippi Alluvial Valley, Stanturf, J.A.; Madsen, P., eds. Boca Raton, FL.
- Louisiana Department of Natural Resources Office of Coastal Management (2010) Defining Louisiana's Coastal Zone: A Science Based Evaluation of the Louisiana Coastal Zone Inland Boundary. August 2010.
- Louisiana Natural Heritage Program (LNHP). 2009. "The Natural Communities of Louisiana." Available at: http://www.wlf.louisiana.gov/sites/default/files/pdf/page_wildlife/6776-Rare%20Natural%20Communities/LA_NAT_COM.pdf. Accessed Nov 2013.
- Lower Mississippi Valley Joint Venture (2007) Restoration, Management and Monitoring of Forest Resources in the Mississippi Alluvial Valley: Recommendations for Enhancing Wildlife Habitat, Version 5.2 (FINAL REPORT). Wilson, R., K. Ribbeck, S. King, and D. Twedt. Lower Mississippi Valley Joint Venture Forest Resource Conservation Working Group.
- Natural Resources Conservation Service (2003) Wetland Restoration, Enhancement, and Management. USDA NRCS Wetland Science Institute, January 2003.
- Natural Resources Conservation Service (2013)¹ The PLANTS Database [website]. U.S. Department of Agriculture, Natural Resources Conservation Service, National Plant Data Center. Accessed November 19, 2013. Available at: <http://plants.usda.gov>
- Natural Resources Conservation Service (2013)² Web Soil Survey [website]. U.S. Department of Agriculture, Natural Resources Conservation Service, Soil Survey Staff. Accessed November 17, 2013. Available at: <http://websoilsurvey.nrcs.usda.gov/app/>
- Oswalt, S.N. (2013) Forest Resources of the Lower Mississippi Alluvial Valley. General Technical Report SRS-GTR-177. Asheville, NC: USDA-Forest Service, Southern Research Station. 29 p.

FIGURES

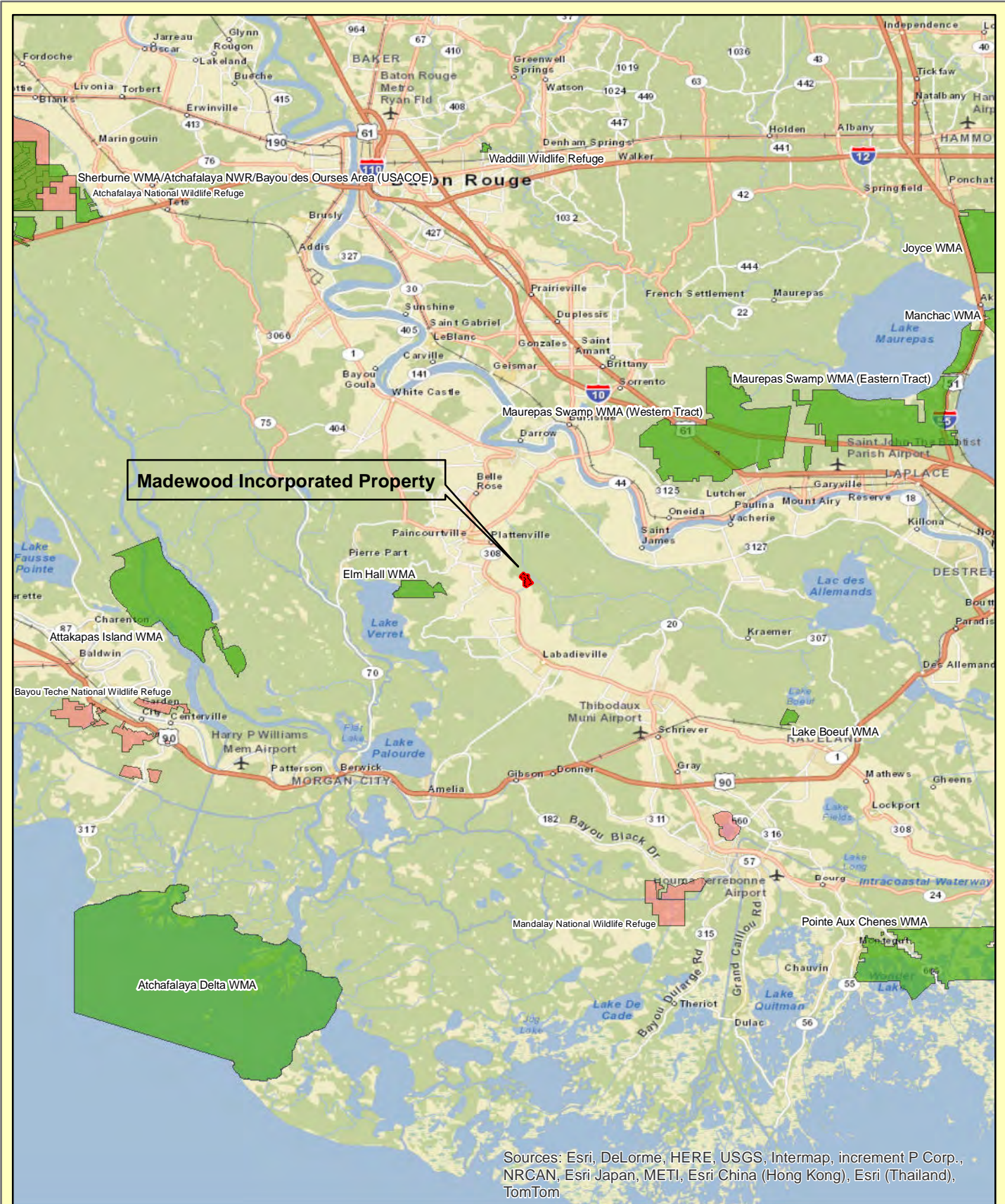

Madewood Incorporated Property

Sources: Esri, DeLorme, HERE, USGS, Intermap, increment P Corp., NRCAN, Esri Japan, METI, Esri China (Hong Kong), Esri (Thailand), TomTom

Legend
 Proposed Bank

GWM Mitigation Bank
Figure 1. Location Map
Madewood Incorporated Tract
 Assumption Parish, Louisiana



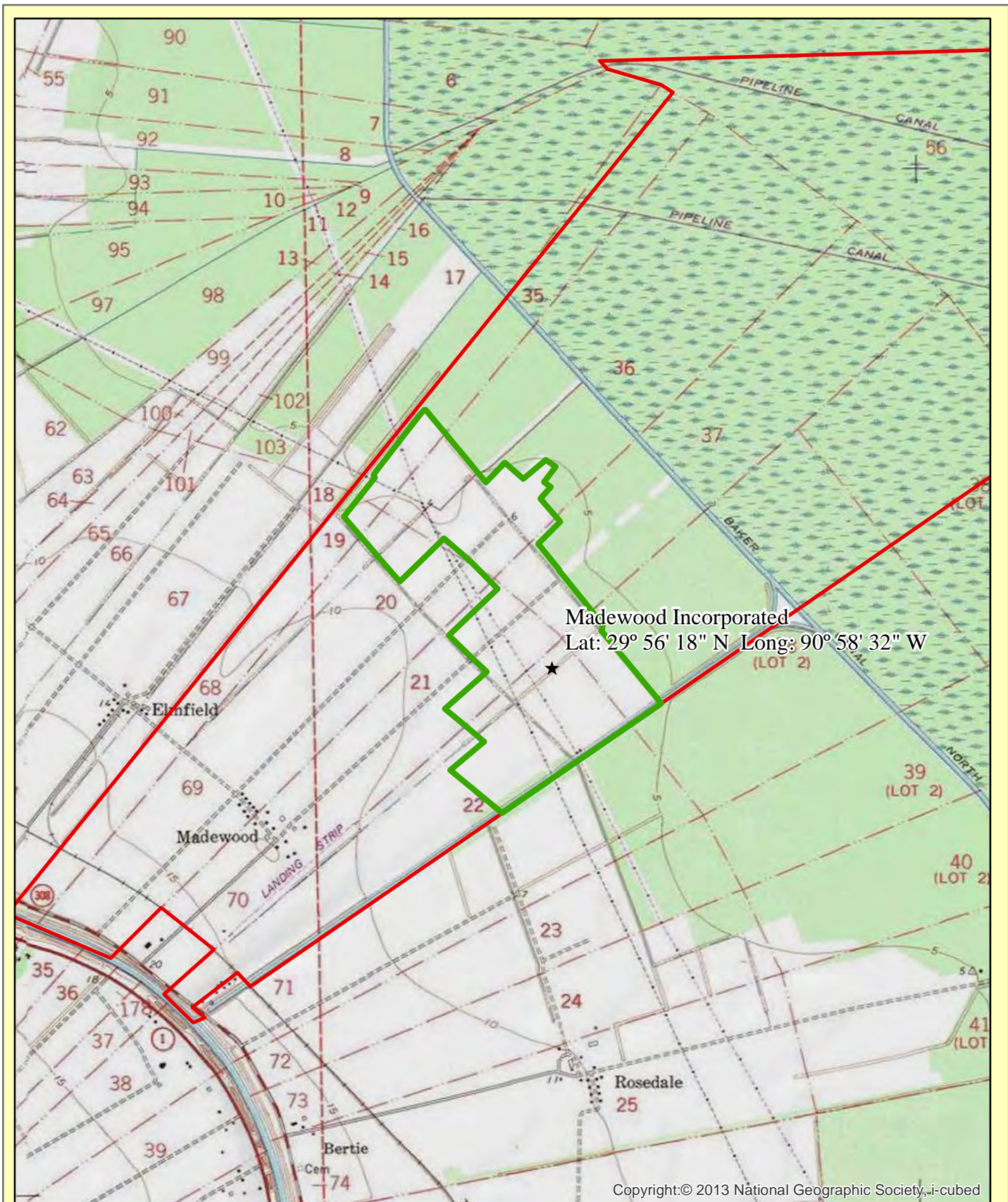

Madewood Incorporated
 Lat: 29° 56' 18" N Long: 90° 58' 32" W

Copyright: © 2013 National Geographic Society, i-cubed

Legend

- Property
- Bank

GWM Mitigation Bank
Figure 2. Site Map
Madewood Incorporated Tract
Acres: 256.2
 Assumption Parish, Louisiana

**DELTA
RESOURCE
MANAGEMENT, LLC**

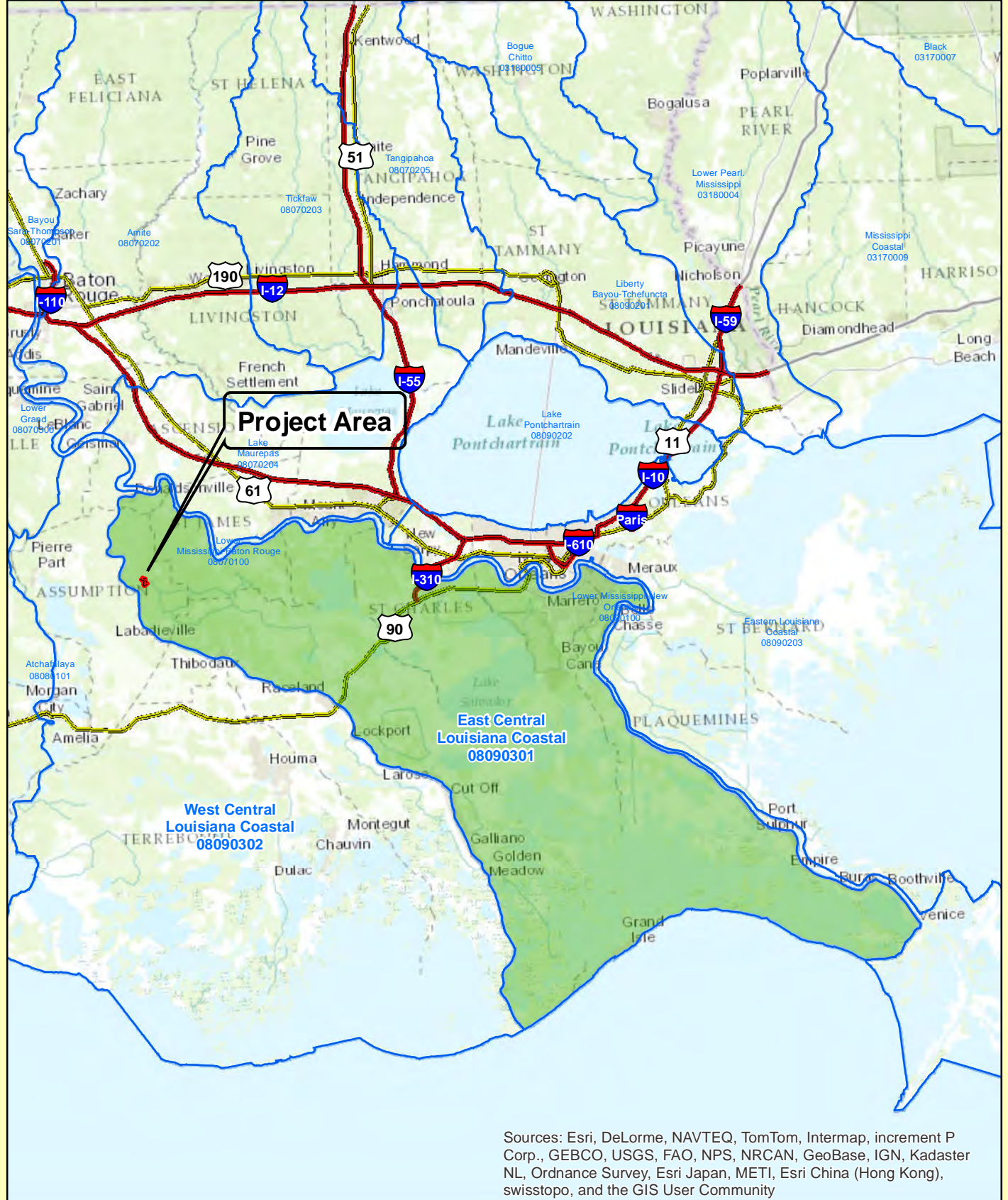



Sources: Esri, DeLorme, NAVTEQ, TomTom, Intermap, increment P Corp., GEBCO, USGS, FAO, NPS, NRCAN, GeoBase, IGN, Kadaster NL, Ordnance Survey, Esri Japan, METI, Esri China (Hong Kong), swisstopo, and the GIS User Community

Legend

- USGS HUC Units
- Primary Service Area**
- East Central Louisiana Coastal

GWM Mitigation Bank
Figure 3. Service Area Map
Madewood Incorporated Tract
 Assumption Parish, Louisiana

0 5 10 20 30
Miles

**DELTA
RESOURCE
MANAGEMENT, LLC**

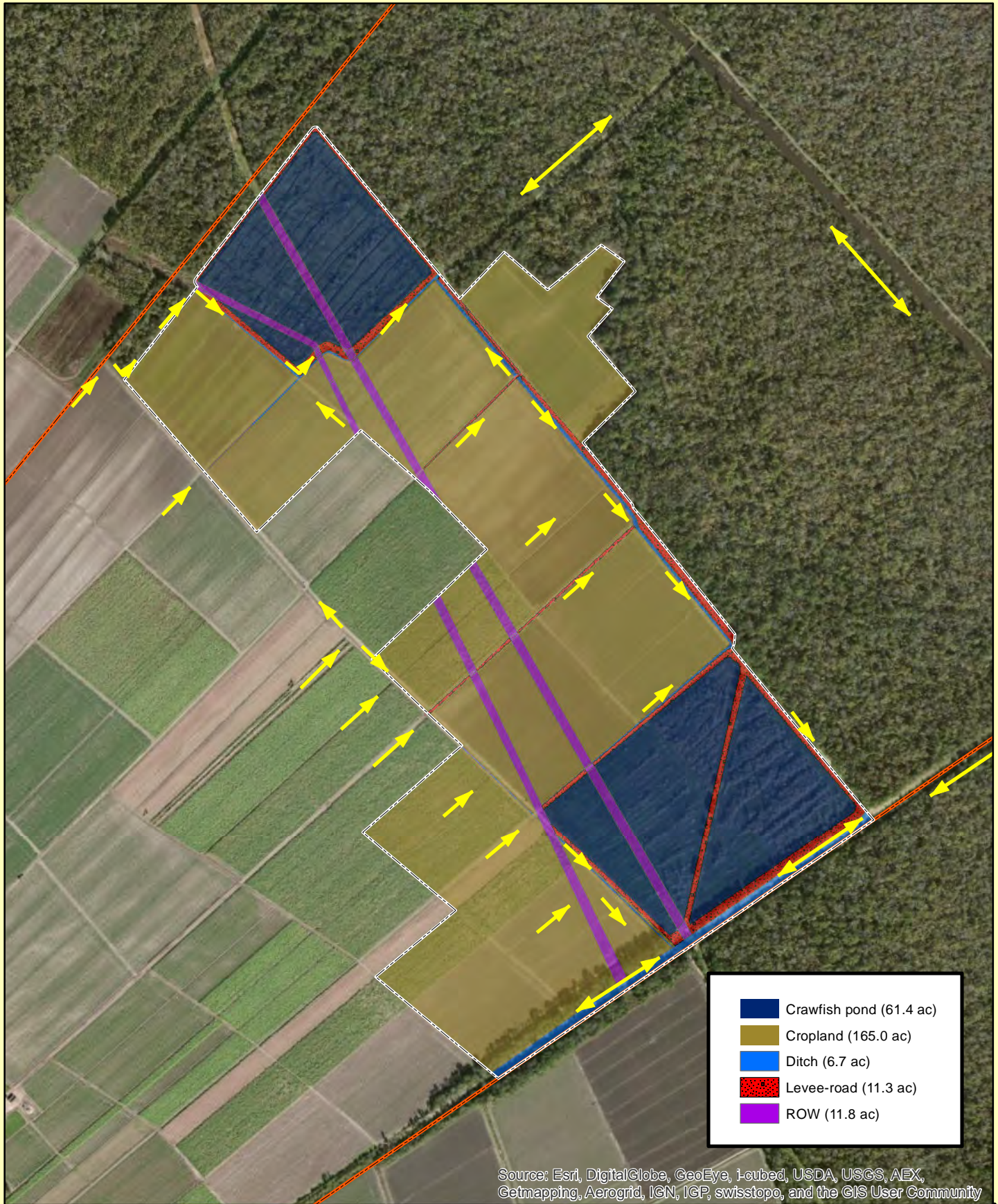

Source: Esri, DigitalGlobe, GeoEye, i-cubed, USDA, USGS, AEX, Getmapping, Aerogrid, IGN, IGP, swisstopo, and the GIS User Community

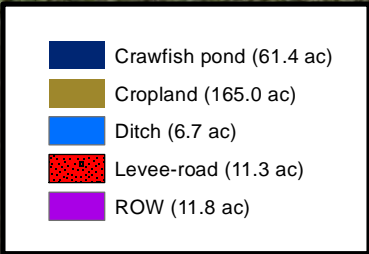

Legend

 Bank (256.2 ac) **Existing Flow**
 Property ➔ flow
➔ ebb and flow

GWM Mitigation Bank
Figure 4. Existing Conditions
Madewood Incorporated Tract
 Assumption Parish, Louisiana

0 330 660 1,320
 Feet

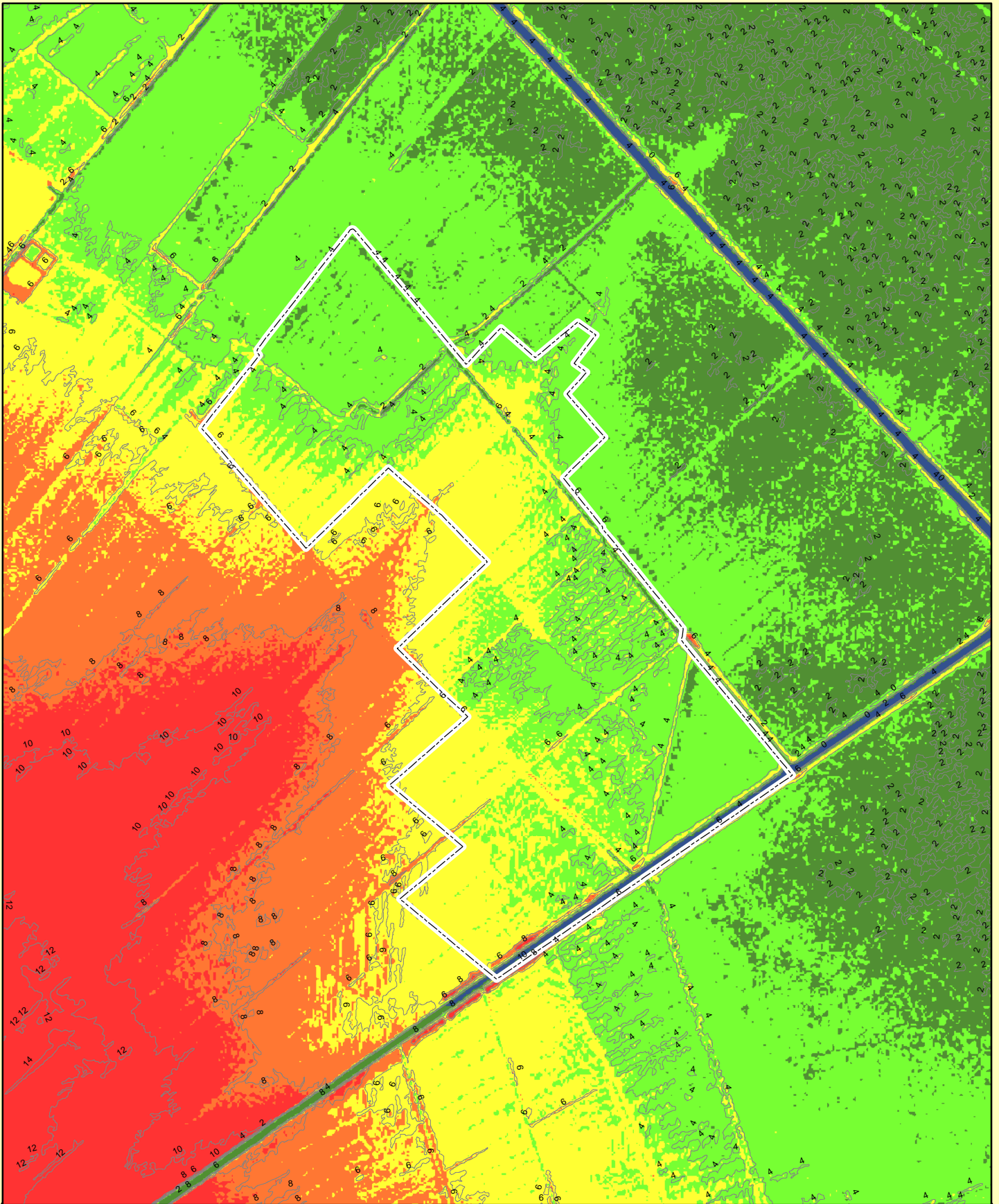

Legend



Elevation (NAVD ft)







GWM Mitigation Bank
 Figure 5. Existing Elevations Map
 Madewood Incorporated Tract
 Assumption Parish, Louisiana





NRCS Soil Types	
 SkA - Schriever clay (121.6 ac)	 SM - Schriever clay, frequently flooded (57.6 ac)
 CmA - Cancienne silt loam (45.2 ac)	 W - Water (5.4 ac)
 TbA - Thibaut clay (26.4)	

Copyright © 2013 Esri, DeLorme, NAVTEQ, TomTom, Source: Esri, Google, Slobe, GeoEye, i-cubed, USDA, USGS, AEX, Getmapping,

Legend	
 Bank (256.2 ac)	
Wetland/Soil Data	
 Data Plot-nonwet	
 Data Plot-wet	
 Soil Sample-hydric	
 Soil Sample-nonhydric	

GWM Mitigation Bank
Figure 6. Soils Map
Madewood Incorporated Tract
 Assumption Parish, Louisiana



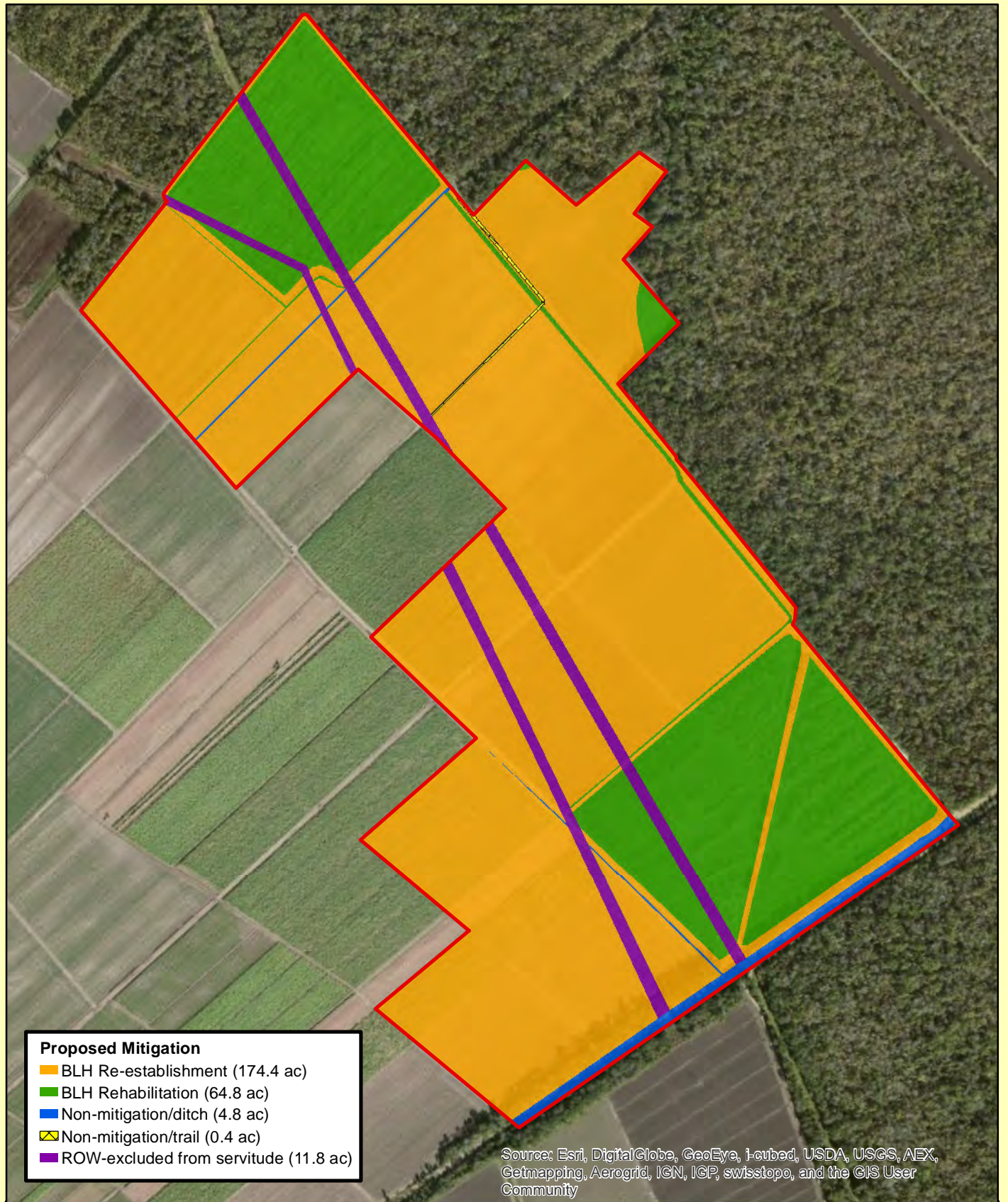

- Proposed Mitigation**
- BLH Re-establishment (174.4 ac)
 - BLH Rehabilitation (64.8 ac)
 - Non-mitigation/ditch (4.8 ac)
 - Non-mitigation/trail (0.4 ac)
 - ROW-excluded from servitude (11.8 ac)

Source: Esri, DigitalGlobe, GeoEye, i-cubed, USDA, USGS, AEX, Getmapping, Aerogrid, IGN, ICP, swisstopo, and the GIS User Community

Legend

Bank (256.2 ac)

GWM Mitigation Bank
Figure 7. Proposed Mitigation Plan Map
Madewood Incorporated Tract
 Assumption Parish, Louisiana

0 200 400 800 1,200

Feet

**DELTA
RESOURCE
MANAGEMENT, LLC**

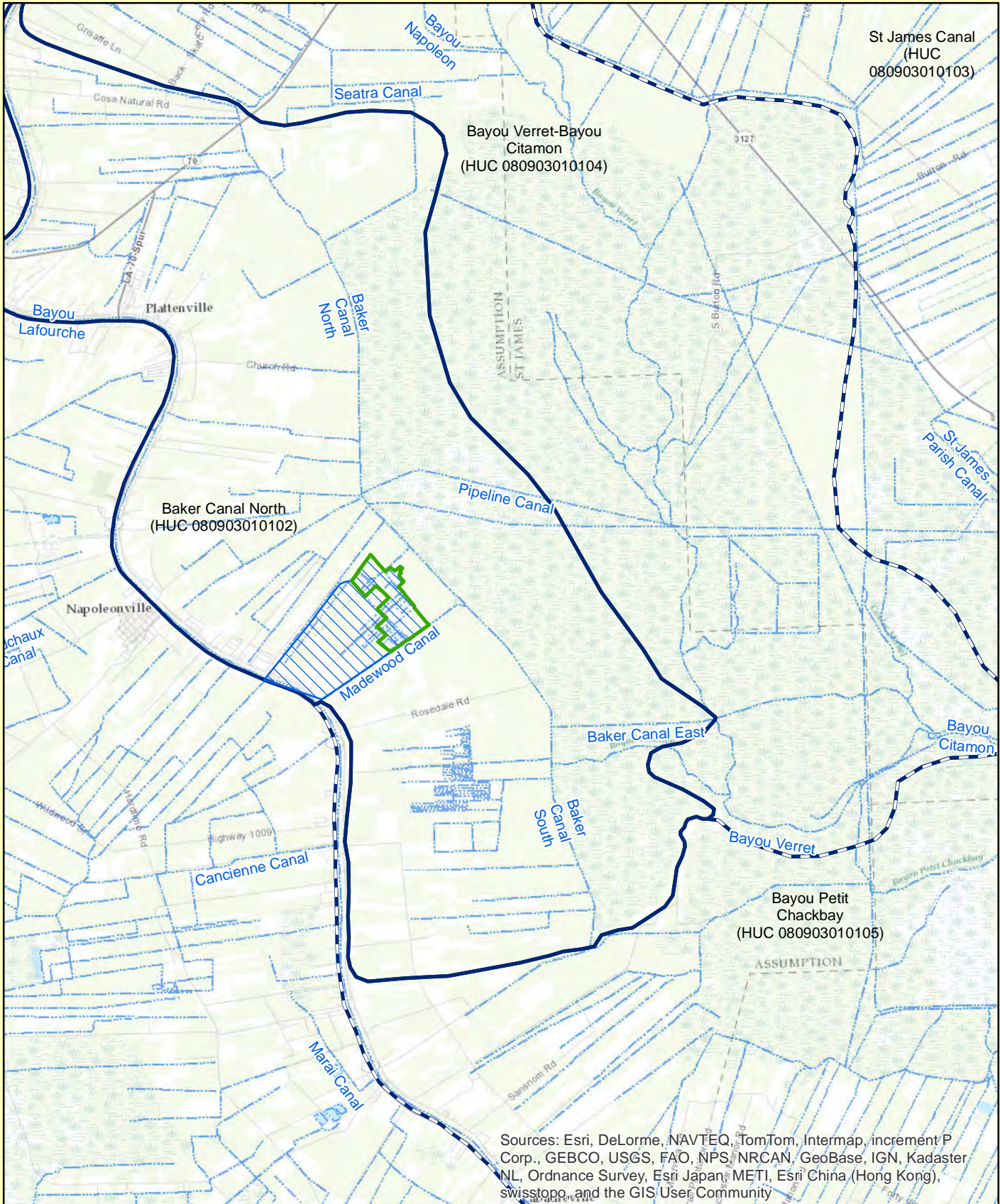

Sources: Esri, DeLorme, NAVTEQ, TomTom, Intermap, increment P Corp., GEBCO, USGS, FAO, NPS, NRCAN, GeoBase, IGN, Kadaster NL, Ordnance Survey, Esri Japan, METI, Esri China (Hong Kong), swisstopo, and the GIS User Community

Legend

- Bank
- Contributing Local Drainage (~950 ac)
- Adjacent 12-Digit HUCs
- Baker Canal North 12-Digit HUC
- Waterways

GWM Mitigation Bank
Figure 8. Potential Watershed Map
Madewood Incorporated Tract
 Assumption Parish, Louisiana

0 0.5 1 2 3
Miles

**DELTA
RESOURCE
MANAGEMENT, LLC**

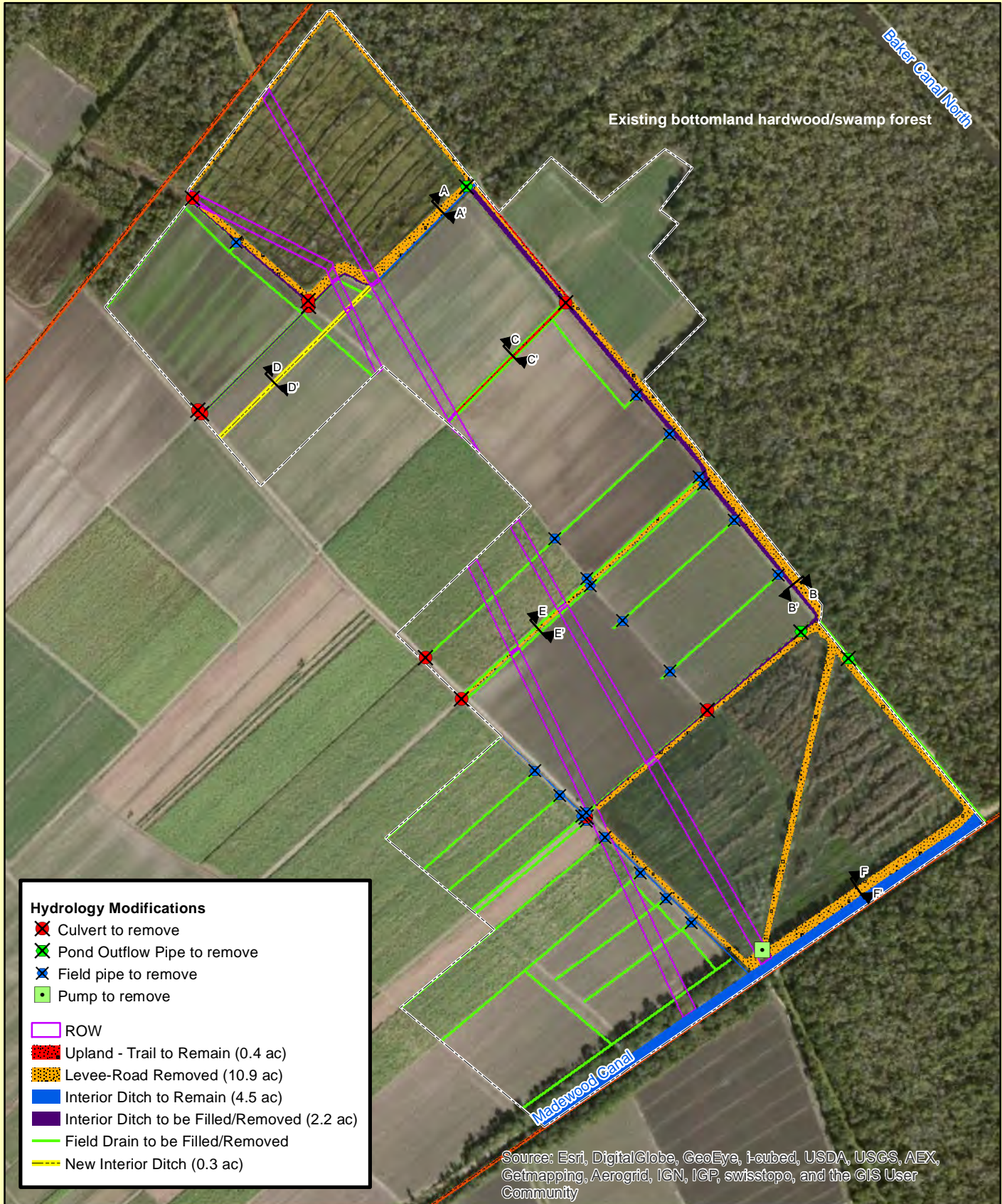

Legend

- Bank (256.2 ac)
- Property

GWM Mitigation Bank
Figure 9
Hydrology Improvements and X-Sections
Madewood Incorporated Tract
 Assumption Parish, Louisiana

0 250 500 1,000
 Feet

DELTA
 RESOURCE
 MANAGEMENT, LLC

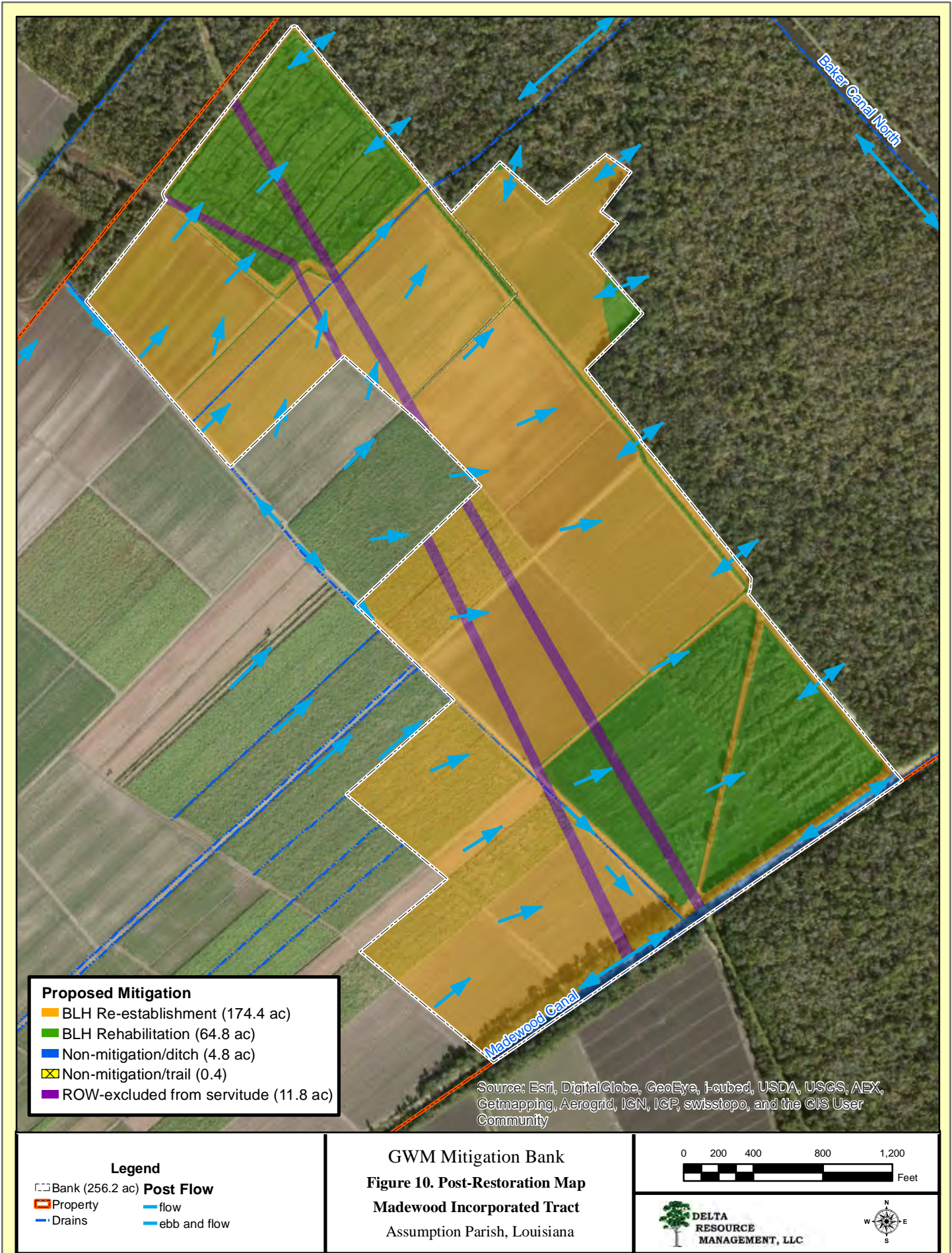

Proposed Mitigation

- BLH Re-establishment (174.4 ac)
- BLH Rehabilitation (64.8 ac)
- Non-mitigation/ditch (4.8 ac)
- Non-mitigation/trail (0.4)
- ROW-excluded from servitude (11.8 ac)

Source: Esri, DigitalGlobe, GeoEye, i-cubed, USDA, USGS, AEX, Getmapping, Aerogrid, IGN, ICP, swisstopo, and the GIS User Community

Legend

- Bank (256.2 ac) **Post Flow**
- Property
- Drains
- flow
- ebb and flow

GWM Mitigation Bank
Figure 10. Post-Restoration Map
Madewood Incorporated Tract
 Assumption Parish, Louisiana

0 200 400 800 1,200
 Feet

**DELTA
 RESOURCE
 MANAGEMENT, LLC**



Appendix A

**Historical USGS
Topographic Maps**

U.S. GEOLOGICAL SURVEY
GEORGE OTIS SMITH, DIRECTOR

(Donaldsonville)

U.S.G.S.
FILE COPY
Geographic Map

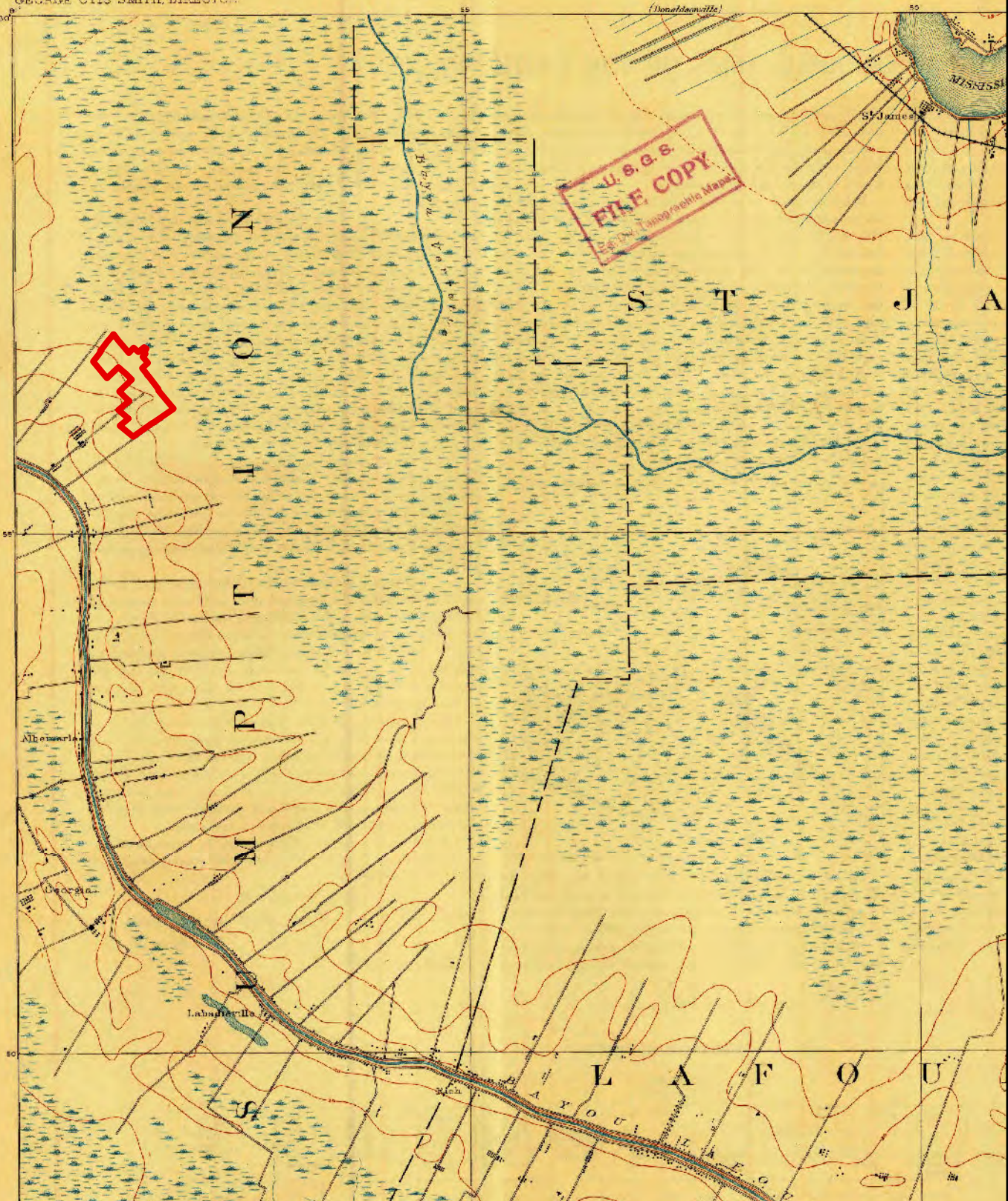

Legend

 Bank (256.2 ac)

GWM Mitigation Bank
USGS 1955 Quad - Thibodaux, LA
Madewood Incorporated Tract
Assumption Parish, Louisiana



 DELTA
RESOURCE
MANAGEMENT, LLC



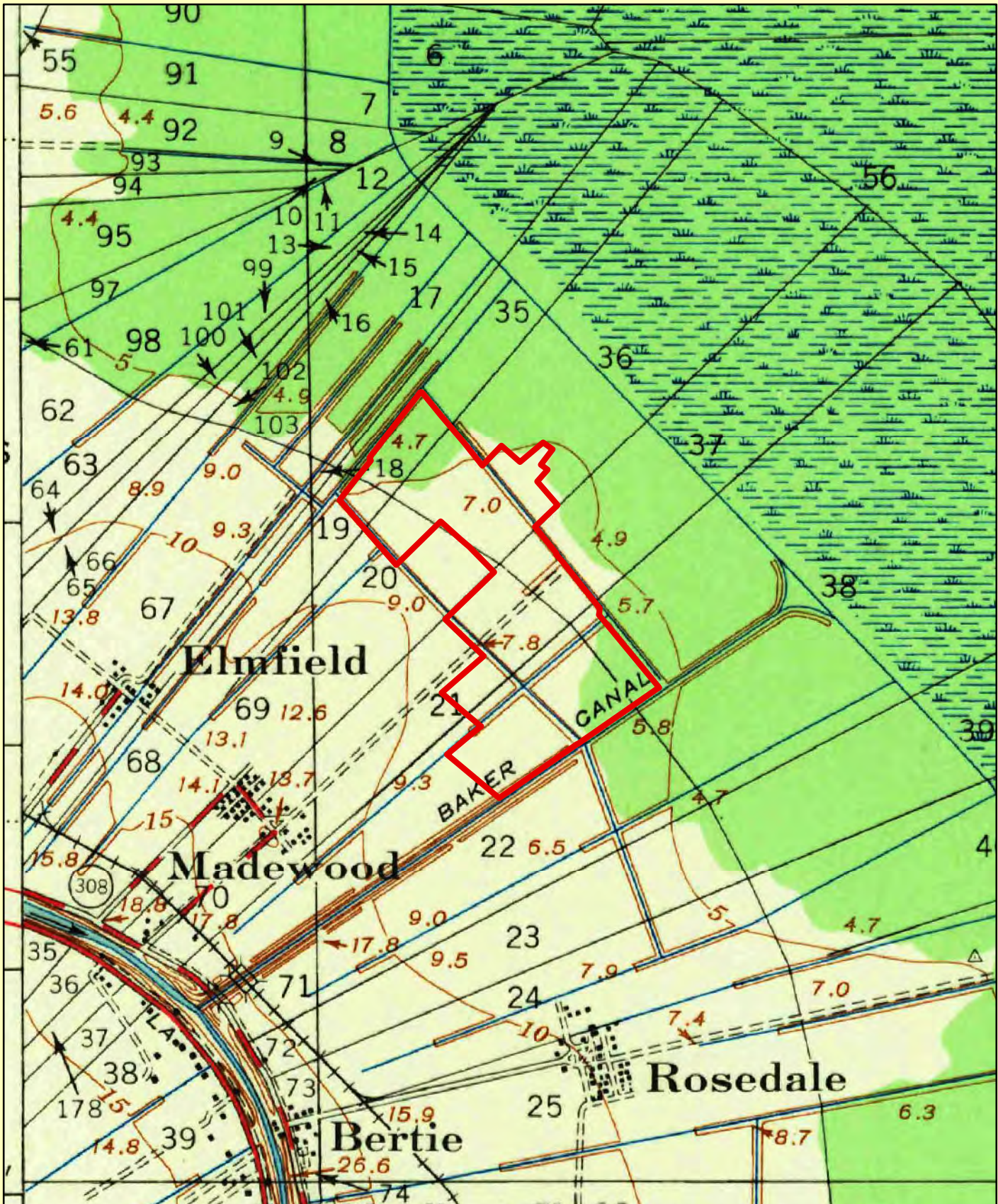

Legend

 Bank (256.2 ac)

GWM Mitigation Bank
 USGS 1955 Quad - Thibodaux, LA
 Madewood Incorporated Tract
 Assumption Parish, Louisiana



Appendix B

CEMVN Jurisdictional Determination & NRCS Wetland Determination



REPLY TO
ATTENTION OF

DEPARTMENT OF THE ARMY
NEW ORLEANS DISTRICT, CORPS OF ENGINEERS
P.O. BOX 60267
NEW ORLEANS, LOUISIANA 70160-0267

SEP 09 2014

Operations Division
Surveillance and Enforcement Section

Mr. Dwayne Templet
Delta Resource Management, L.L.C.
36504 Highway 30
Geismar, Louisiana 70734

Dear Mr. Templet:

Reference is made to your request, on behalf of GWM, L.L.C., for a U.S. Army Corps of Engineers' (Corps) jurisdictional determination on three properties: the Glenwood site in Sections 128, 143, 164, 163, 109, Township 13 South, Range 14 East; the Madewood site in Sections 35, 36, 37, 38 19, 20, 21, 22, Township 13 South, Range 15 East; and the Woodlawn site in Sections 25, 26, 27, 28, 29, 43, 44, 45, Township 13 South, Range 15 East; Assumption Parish, Louisiana (enclosed map). Specifically, this property is identified as three potential mitigation banks.

Based on review of recent maps, aerial photography, soils data, information provided with your request, and a brief site investigation, we have determined that part of the property is wetland and may be subject to Corps' jurisdiction. The approximate limits of the wetland are designated in red on the map. A Department of the Army (DA) permit under Section 404 of the Clean Water Act will be required prior to the deposition or redistribution of dredged or fill material into wetlands that are waters of the United States. Additionally, a DA permit will be required if you propose to deposit dredged or fill material into other waters subject to Corps' jurisdiction. Other waters that may be subject to Corps' jurisdiction are indicated in blue on the map.

Please be advised that this property is in the Louisiana Coastal Zone and a Coastal Use Permit may be required prior to initiation of any activities on this site. For additional information, contact Ms. Christine Charrier, Office of Coastal Management, Louisiana Department of Natural Resources at (225) 342-7953.

You and your client are advised that this preliminary jurisdictional determination is valid for a period of 5 years from the date of this letter unless new information warrants revision prior to the expiration date or the District Commander has identified, after public notice and comment, that specific geographic areas with rapidly changing environmental conditions merit re-verification on a more frequent basis.

Should there be any questions concerning these matters, please contact Mr. Brandon Gaspard at (504) 862-1280 and reference our Account No.

MVN-2014-01186-SE. If you have specific questions regarding the permit process or permit applications, please contact our Western Evaluation Section at (504) 862-2261.

Sincerely,

A handwritten signature in blue ink, appearing to read "Robert A. Hoffman".A small handwritten signature in blue ink, appearing to read "MS".

Martin S. Mayer
Chief, Regulatory Branch

Enclosures

USAGE w/ cons DATA
 FSV / IH Date: 27 Aug 2014
 Botanist: GASPARO
 Requestor: TEMPLET
 # MVN- 2014-01186SE
 - WETLAND
 - NON-WETLAND
 - WATERS of US (WU)
 2 OF 3

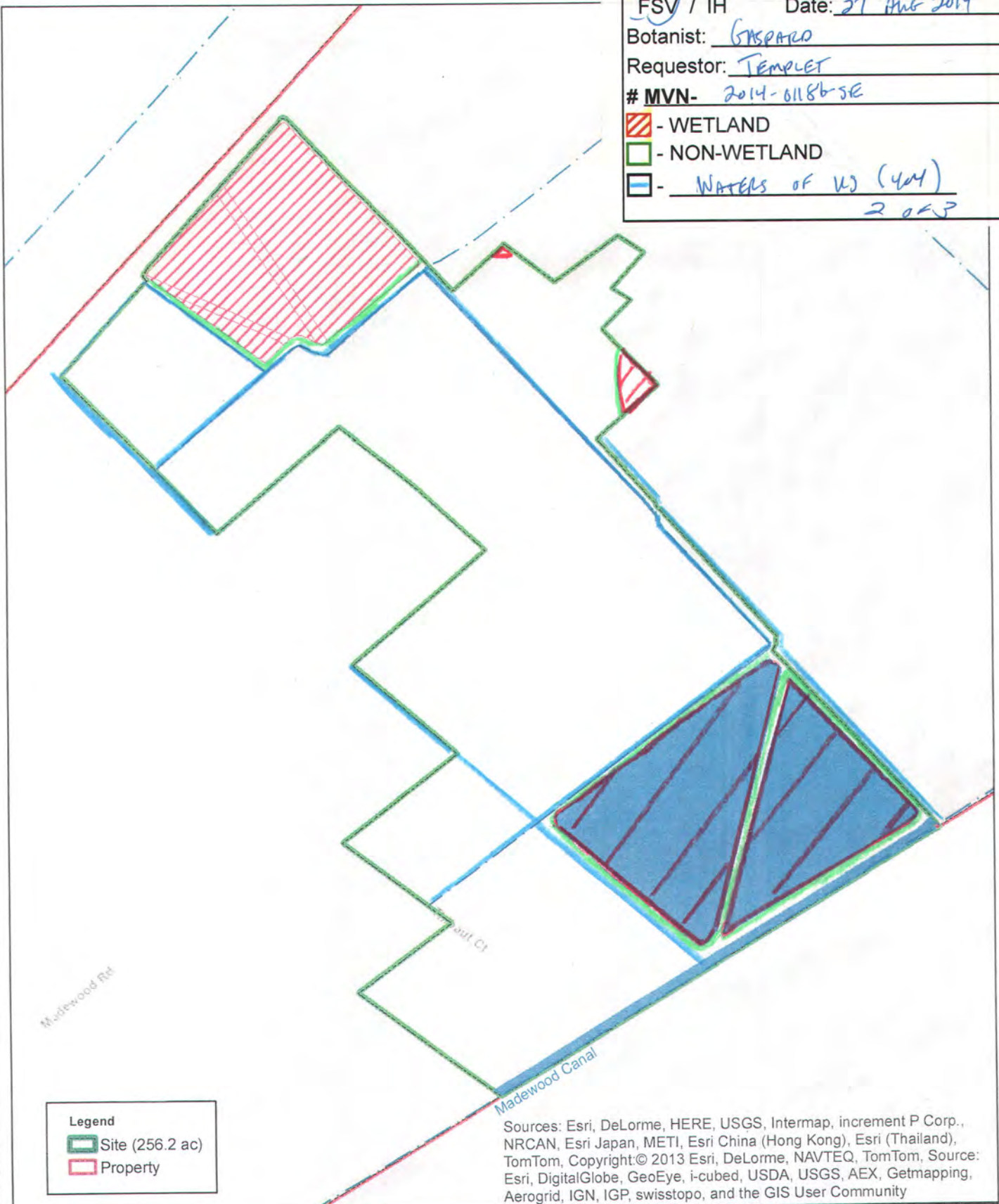

Legend
 Site (256.2 ac)
 Property

Sources: Esri, DeLorme, HERE, USGS, Intermap, increment P Corp., NRCAN, Esri Japan, METI, Esri China (Hong Kong), Esri (Thailand), TomTom, Copyright:© 2013 Esri, DeLorme, NAVTEQ, TomTom, Source: Esri, DigitalGlobe, GeoEye, i-cubed, USDA, USGS, AEX, Getmapping, Aerogrid, IGN, IGP, swisstopo, and the GIS User Community

U.S. ARMY CORPS OF ENGINEERS
PRELIMINARY
JURISDICTIONAL DETERMINATION

Wetland/Other Waters of the U.S. Map
 Madewood Incorporated Tract
 Secs 19-22 & 35-38; T13S, R15E
 Assumption Parish, Louisiana



DELTA RESOURCE MANAGEMENT, LLC





HIGHLY ERODIBLE LAND AND WETLAND CONSERVATION DETERMINATION

Name	MADEWOOD, INC.	Request Date:	1/27/2014	County:	ASSUMPTION
Address:	P.O. BOX 1058, NAPOLEONVILLE, LA. 70390-1058	Agency or Person Requesting Determination:	JOSEPH W. THIBAUT	Tract No:	513
				FSA Farm No.:	807

Section I - Highly Erodible Land

Is a soil survey now available for making a highly erodible land determination?	Yes
Are there highly erodible soil map units on this farm?	No

Fields in this section have undergone a determination of whether they are highly erodible land (HEL) or not; fields for which an HEL Determination has not been completed are not listed. In order to be eligible for USDA benefits, a person must be using an approved conservation system on all HEL.

Field(s)	HEL(Y/N)	Sodbust (Y/N)	Acres	Determination Date
NONE				

The Highly Erodible Land determination was completed in the Office

Section II - Wetlands

Fields in this section have had wetland determinations completed. See the Definition of Wetland Label Codes for additional information regarding allowable activities under the wetland conservation provisions of the Food Security Act and/or when wetland determinations are necessary to determine USDA program eligibility.

Field(s)	Wetland Label*	Occurrence Year (CW)	Acres	Determination Date	Certification Date
116	PC		3.02	06/12/2014	
117	PC		3.95	06/12/2014	
127	PC/NW		13.72	06/12/2014	
151	PC		6.72	06/12/2014	
155	PC		4.82	06/12/2014	

The wetland determination was completed in the Office It was Mailed to the person on 06/13/2014

Remarks:
Do not alter the vegetation or hydrology on this tract without first contacting the U.S. Army Corps Of Engineers.

I certify that the above determinations are correct and were conducted in accordance with policies and procedures contained in the National Food Security Act Manual.

Signature Designated Conservationist	Date
<i>Daniel P. Peden</i>	06/12/2014

The U.S. Department of Agriculture (USDA) prohibits discrimination in all its programs and activities on the basis of race, color, national origin, gender, religion, age, disability, political beliefs, sexual orientation, and marital or family status. (Not all prohibited bases apply to all programs.) Persons with disabilities who require alternative means for communication of program information (Braille, large print, audiotape, etc.) should contact USDA's TARGET Center at 202-720-2600 (voice and TDD). To file a complaint of discrimination, write USDA, Assistant Secretary for Civil Rights, 1400 Independence Avenue, S.W., Stop 9410, Washington, DC 20250-9410, or call toll-free at (866) 632-9992 (English) or (800) 877-8339 (TDD) or (866) 377-8642 (English Federal-relay) or (800) 845-6136 (Spanish Federal-relay). USDA is an equal opportunity provider and employer.

CPA-026e Supplemental Worksheet

Section II - Wetlands

<u>Field(s)</u>	<u>Wetland Label*</u>	<u>Occurrence Year (CW)**</u>	<u>Acres</u>	<u>Preliminary Determination Date</u>	<u>Final Certification Date</u>
158	PC		13.88	06/12/2014	
162	PC/NW		9.70	06/12/2014	
163	PC/NW		7.55	06/12/2014	
168	PC		2.59	06/12/2014	
170	PC		6.30	06/12/2014	
171	PC		4.03	06/12/2014	
172	PC		17.33	06/12/2014	
176	PC/NW		16.34	06/12/2014	
181	PC/NW		5.09	06/12/2014	
182	PC/NW		16.77	06/12/2014	
218	PC		26.11	06/12/2014	
ALL OTHER FIELDS	NW		548.90	06/12/2014	

Remarks:

Fields that have been labeled Prior Converted (PC) and Prior Converted/Non-Wetland (PC/NW) were cleared and an agricultural commodity was planted prior to 12/23/1985.

This Preliminary Technical Determination will become final thirty (30) days after receipt of the preliminary technical decision by you the participant, unless the determination is appealed in a timely manner as provided for in this regulation. Once all of the appeal procedures are exhausted, or the Preliminary Technical Determination is not appealed within the allotted time, the Determination becomes a final, Certified Technical Determination.

This certified wetland determination/delineation has been conducted for the purpose of implementing the wetland conservation provisions of the Food Security Act of 1985. This determination/delineation may not be valid for identifying the extent of the U.S. Army Corps of Engineers (C.O.E.'s) Clean Water Act jurisdiction for this site. If you intend to conduct any activity that constitutes a discharge of dredged or fill material into wetlands or other waters, or perform any of the following activities: (1) Land clearing (2) Drainage (open ditching) (3) Drainage maintenance (4) Filling, leveling, dredging (5) Land use changes, you should request a jurisdictional determination from the local office of the C.O.E. prior to starting the work.

The U.S. Department of Agriculture (USDA) prohibits discrimination in all of its programs and activities on the basis of race, color, national origin, age, disability, and where applicable, sex, marital status, familial status, parental status, religion, sexual orientation, political beliefs, genetic information, reprisal, or because all or part of an individual's income is derived from any public assistance program. (Not all prohibited bases apply to all programs.) Persons with disabilities who require alternative means for communication of program information (Braille, large print, audiotape, etc.) should contact USDA's TARGET Center at (202) 720-2600 (voice and TDD). To file a complaint of discrimination, write to USDA, Assistant Secretary for Civil Rights, Office of the Assistant Secretary for Civil Rights, 1400 Independence Avenue, S.W., Stop 9410, Washington, DC 20250-9410, or call toll-free at (866) 632-9992 (English) or (800) 877-8339 (TDD) or (866) 377-8642 (English Federal-relay) or (800) 845-6136 (Spanish Federal-relay). USDA is an equal opportunity provider and employer.

*DEFINITIONS OF WETLAND LABELS

AW	<u>Artificial Wetland</u> : An area that was formerly a non-wetland area under natural conditions but now exhibits wetland characteristics because of the influence of human activities. These areas are exempt from the Food Security Act of 1985, as amended. This label includes irrigation induced wetlands.
CC	<u>Commenced Conversion</u> : A wetland, farmed wetland, farmed wetland pasture, or converted wetland on which the conversion began but was not completed before December 23, 1985, was approved by FSA to continue, and the conversion was completed by January 1, 1995.
CPD	<u>COE Permit with Mitigation</u> : A converted wetland authorized by a permit issued under Section 404 of the Clean Water Act. Production of agricultural commodities is allowed subject to conditions of the permit.
CMW	<u>Categorical Minimal Effect</u> : A wetland that meets specific categories of conversion activities that have been determined by NRCS to have minimal effect, individually and cumulatively, on the functions and values of the wetland and the wetlands in the watershed.
CW	<u>Converted Wetland</u> : A wetland converted between December 23, 1985, and November 28, 1990. Production of an agricultural commodity or additional manipulation of these areas will yield USDA benefit ineligibility. Also, these areas are wetlands converted after December 23, 1985, by a county, drainage district, or similar entity. For these instances, production of an agricultural commodity or forage for mechanical harvest or additional manipulation will cause ineligibility for USDA program benefits.
CW+year	<u>Converted Wetland + (year the conversion occurred)</u> : A wetland converted after November 28, 1990, where the USDA program participant is ineligible for benefits until the wetland is restored or mitigated unless an exemption applies.
CWNA	<u>Converted Wetland Non-Agricultural Use</u> : A wetland converted after November 28, 1990, to a use other than agricultural commodity production. Label not used for certified wetland determinations completed after 2/2008.
CWTE	<u>Converted Wetland Technical Error</u> : A wetland converted or commenced after December 23, 1985, based on an incorrect NRCS determination. This label does not apply to obvious wetlands as defined in the National Food Security Act Manual.
FW	<u>Farmed Wetland</u> : A wetland that was manipulated and planted before December 23, 1985, but still meets inundation or saturation criteria. These areas may be farmed and maintained as documented before December 23, 1985, as long as they are not abandoned (i.e., management or maintenance for commodity production ceased for 5 consecutive years).
FWP	<u>Farmed Wetland Pasture or Hayland</u> : A wetland that is used for pasture or haying, was manipulated and planted before December 23, 1985, but still meets the inundation or saturation criteria. These areas may be farmed and maintained as documented before December 23, 1985, as long as they are not abandoned (i.e., management or maintenance for commodity production ceased for 5 consecutive years).
MIW	<u>Mitigation Exemption</u> : A converted wetland, farmed wetland or farmed wetland pasture of which the acreage, functions and values lost have been compensated for through an NRCS-approved mitigation plan.
MW	<u>Minimal Effect Exemption</u> : A converted wetland that is exempt from the wetland conservation provisions of the Food Security Act of 1985, as amended, based on an NRCS determination that the conversion has or will have a minimal effect, individually and cumulatively, on the functions and values of the wetland and the wetlands in the watershed.
MWM	<u>Mitigation Site</u> : The site of wetland restoration, enhancement, or creation serving as mitigation for the mitigation exemption (MIW) site.
NI	<u>Not Inventoried</u> : An area where no wetland determination has been conducted. Label not used for certified wetland determinations completed after 2/2008.
NW	<u>Non-Wetland</u> : An area that does not contain a wetland. Also includes wetlands converted before December 23, 1985, but a commodity crop was not produced and the area does not meet wetland criteria (not been abandoned).
PC	<u>Prior-Converted Cropland</u> : A wetland converted to cropland before December 23, 1985, and as of December 23, 1985, was capable of being cropped and did not meet farmed wetland hydrology criteria. These areas are not subject to the wetland conservation provisions of the Food Security Act of 1985, as amended, unless further drainage manipulation affects adjacent wetlands.
PC/NW	<u>Prior Converted Cropland/Non-Wetland</u> : An area that contains both PC and NW.
TP	<u>Third-Party Exemption</u> : A wetland converted after December 23, 1985, by a third party who is not associated with the participant, and the conversion is not a result of a scheme or device. A third party does not include predecessors in interest on the tract, drainage districts, or other local government entities.
W	<u>Wetland</u> : An area meeting wetland criteria that was not converted after December 23, 1985. These areas include farmed wetlands and farmed wetland pasture that have been abandoned.
WX	<u>Manipulated Wetlands</u> : A wetland manipulated after December 23, 1985, but the manipulation was not for the purpose of making production possible and production was not made possible. These areas include wetlands manipulated by drainage maintenance agreements.

The U.S. Department of Agriculture (USDA) prohibits discrimination in all its programs and activities on the basis of race, color, national origin, gender, religion, age, disability, political beliefs, sexual orientation, and marital or family status. (Not all prohibited bases apply to all programs.) Persons with disabilities who require alternative means for communication of program information (Braille, large print, audiotape, etc.) should contact USDA's TARGET Center at 202-720-2600 (voice and TDD). To file a complaint of discrimination, write USDA, Assistant Secretary for Civil Rights, 1400 Independence Avenue, S.W., Stop 9410, Washington, DC 20250-9410, or call toll-free at (866) 632-9992 (English) or (800) 877-8339 (TDD) or (866) 377-8642 (English Federal-relay) or (800) 845-6136 (Spanish Federal-relay). USDA is an equal opportunity provider and employer.

WETLAND DETERMINATION with SOILS

Date: 6/12/2014

Customer(s): MADEWOOD, INC.

District: LOWER DELTA S.W.C.D.

Approximate Acres: 706.82

Quad: MADEWOOD

T13S / R14E / Sec 68-71 T13S / R15E / Sec 19-22

Field Office: DONALDSONVILLE

Agency: USDA / NRCS

Assisted By: DANIEL DIDIER

State, County: LA., ASSUMPTION

FN-807 / T-513

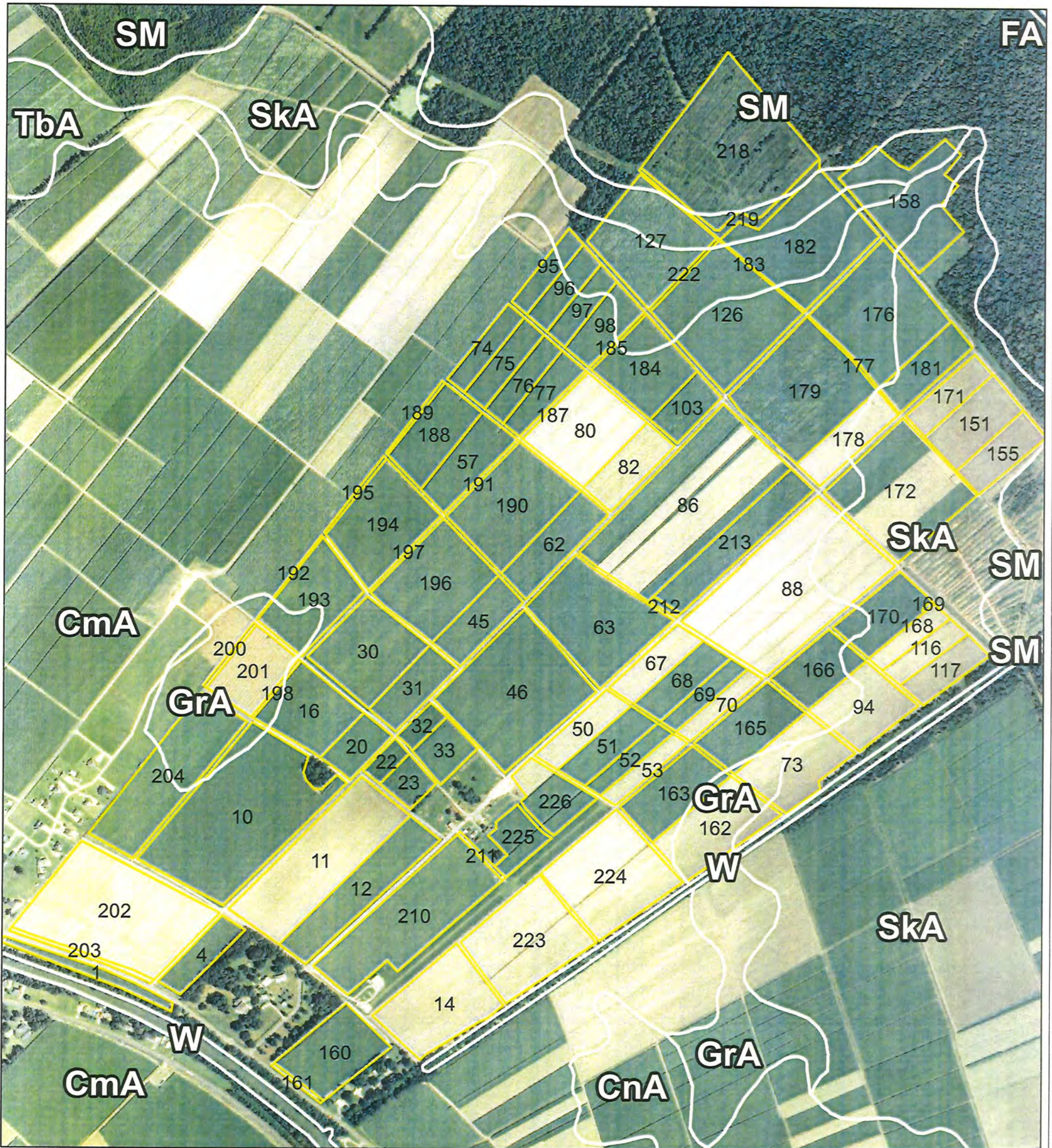

Legend

See the NRCS-CPA-026e dated 6/12/2014 for the Wetland Labels assigned to these fields.

soilmu_a_la007

clu_copy_a_la007



1:10,200



Appendix C

Hydrology Restoration Drawings

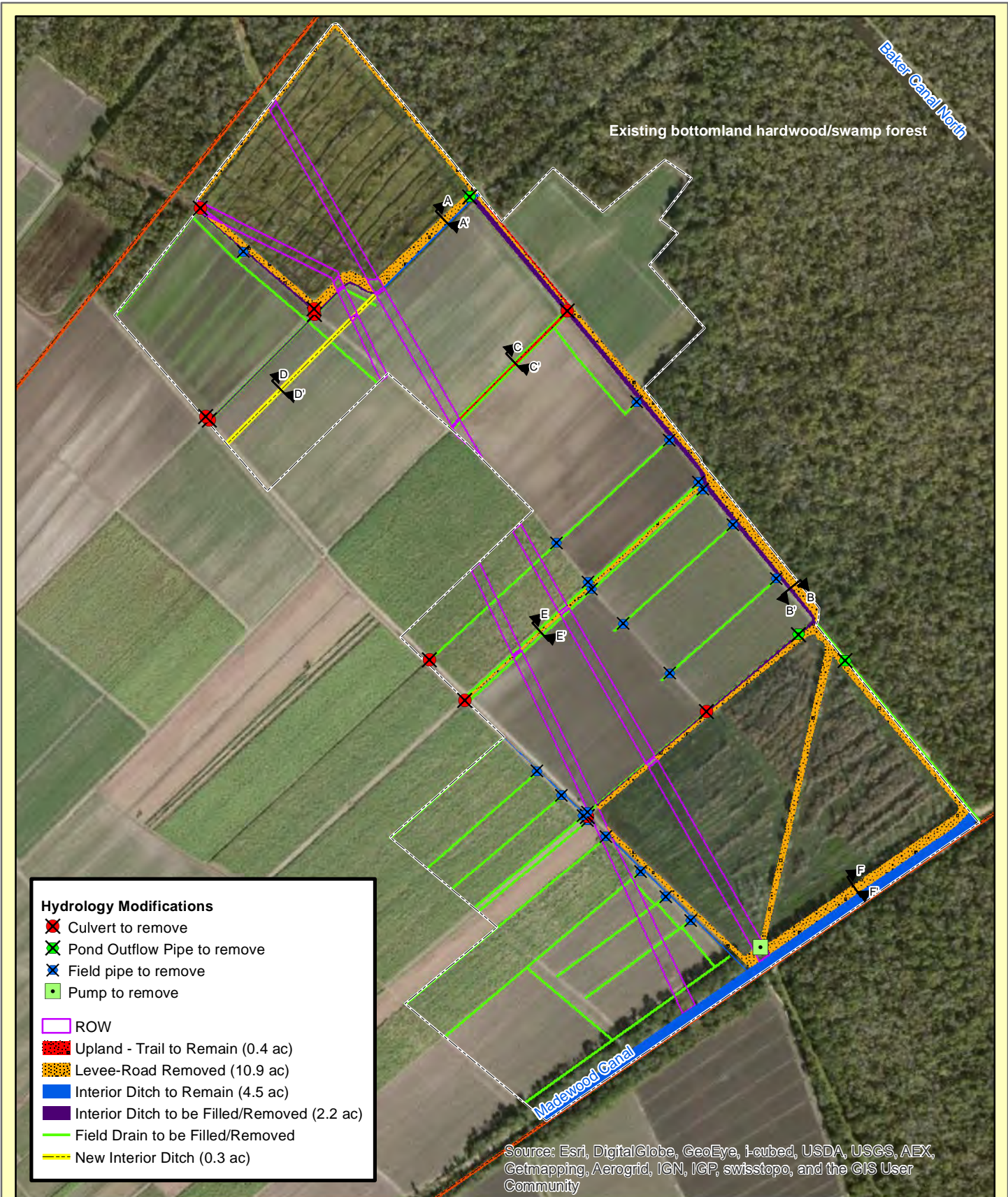

Baker Canal North

Existing bottomland hardwood/swamp forest

Madewood Canal

Hydrology Modifications

- ✗ Culvert to remove
- ✗ Pond Outflow Pipe to remove
- ✗ Field pipe to remove
- Pump to remove

ROW
 Upland - Trail to Remain (0.4 ac)
 Levee-Road Removed (10.9 ac)
 Interior Ditch to Remain (4.5 ac)
 Interior Ditch to be Filled/Removed (2.2 ac)
 Field Drain to be Filled/Removed
 New Interior Ditch (0.3 ac)



Source: Esri, DigitalGlobe, GeoEye, i-cubed, USDA, USGS, AEX, Getmapping, Aerogrid, IGN, IGP, swisstopo, and the GIS User Community

Legend

- Bank (256.2 ac)
- Property

GWM Mitigation Bank
Plan View
Hydrology Improvements and X-Sections
Madewood Incorporated Tract
 Assumption Parish, Louisiana

0 250 500 1,000
 Feet

PRE-CONSTRUCTION SECTION

NTS
Vertically Exaggerated



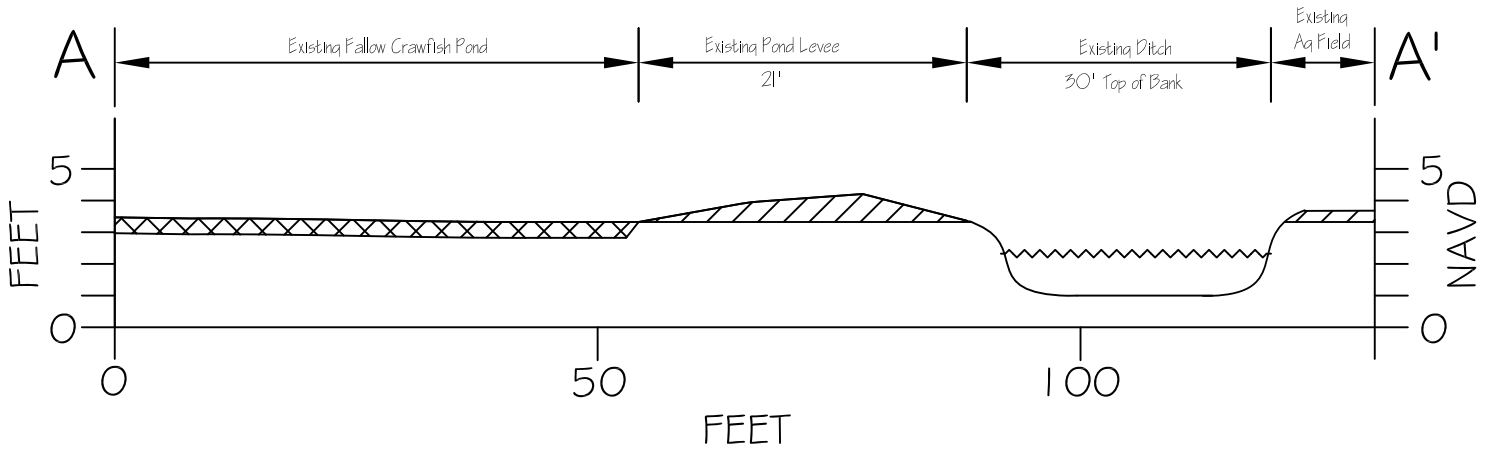

*Cut material deposited in ditches/ponds to be filled or in nonwetlands.

POST CONSTRUCTION SECTION

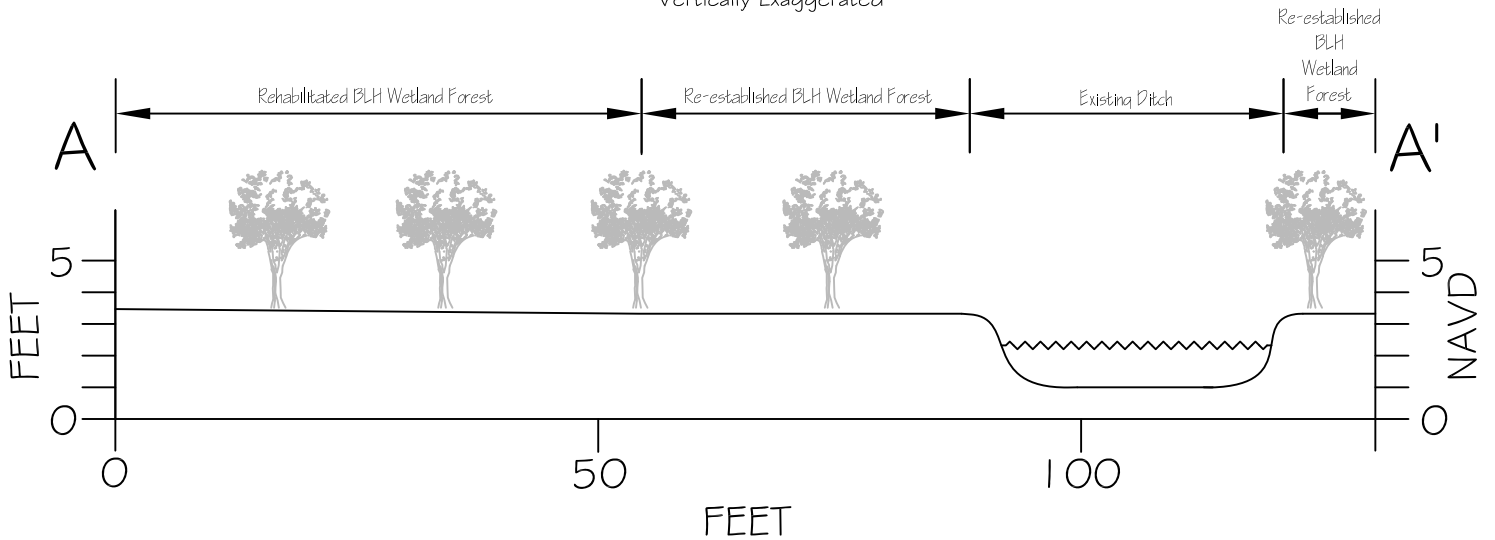
NTS
Vertically Exaggerated



-  Proposed Cut
-  Proposed Fill

Map Notes:

Elevations from LIDAR data & field observations



Delta Resource Mgmt LLC

Prairieville, LA
CROSS SECTIONS A-A'
MADEWOOD TRACT
ASSUMPTION PARISH, LA

Created: AGB

Approved: DT

Date: 07/31/2014

Map No.:

PRE-CONSTRUCTION SECTION

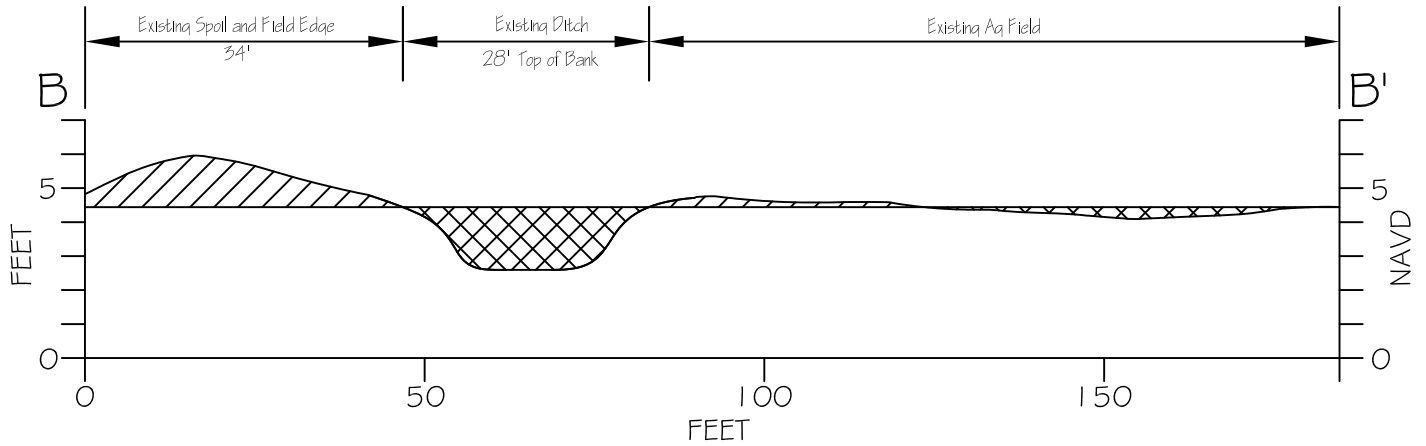

NTS
Vertically Exaggerated

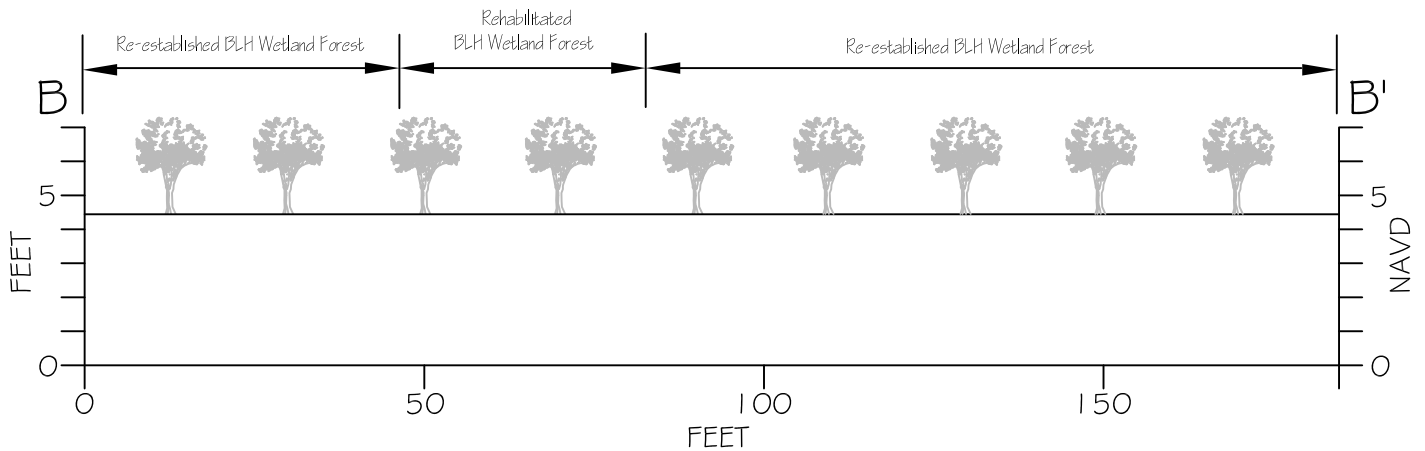

POST CONSTRUCTION SECTION

NTS
Vertically Exaggerated



-  Proposed Cut
-  Proposed Fill

Map Notes:

Elevations from LIDAR data & field observations



Delta Resource Mgmt LLC

Prairieville, LA
CROSS SECTIONS B - B'
MADEWOOD TRACT
ASSUMPTION PARISH, LA

Created: AGB

Approved: DT

Date: 07/31/2014

Map No.:

PRE-CONSTRUCTION SECTION

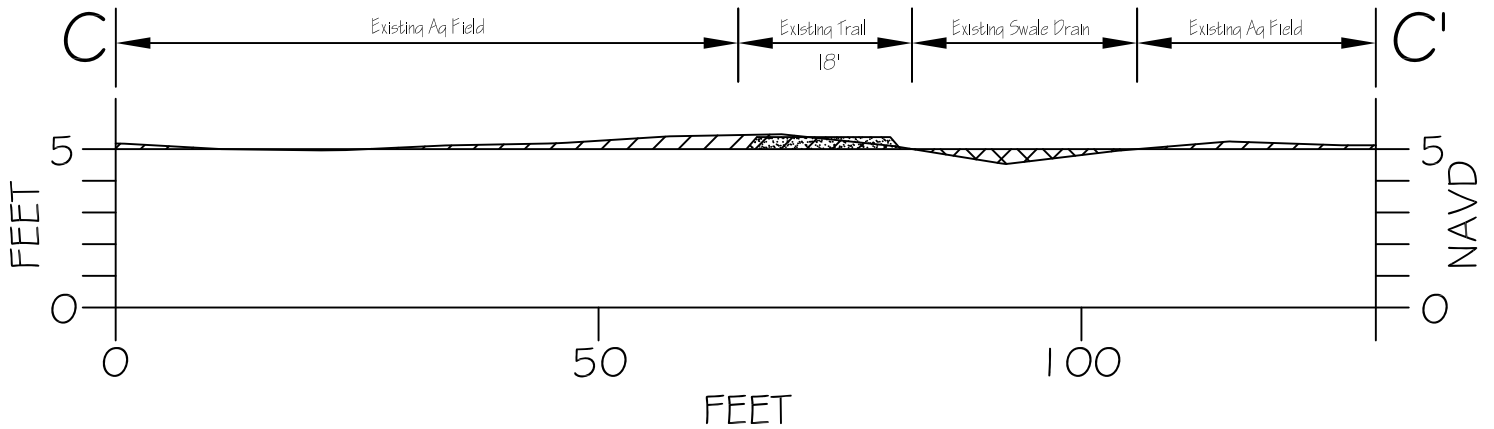

NTS
Vertically Exaggerated

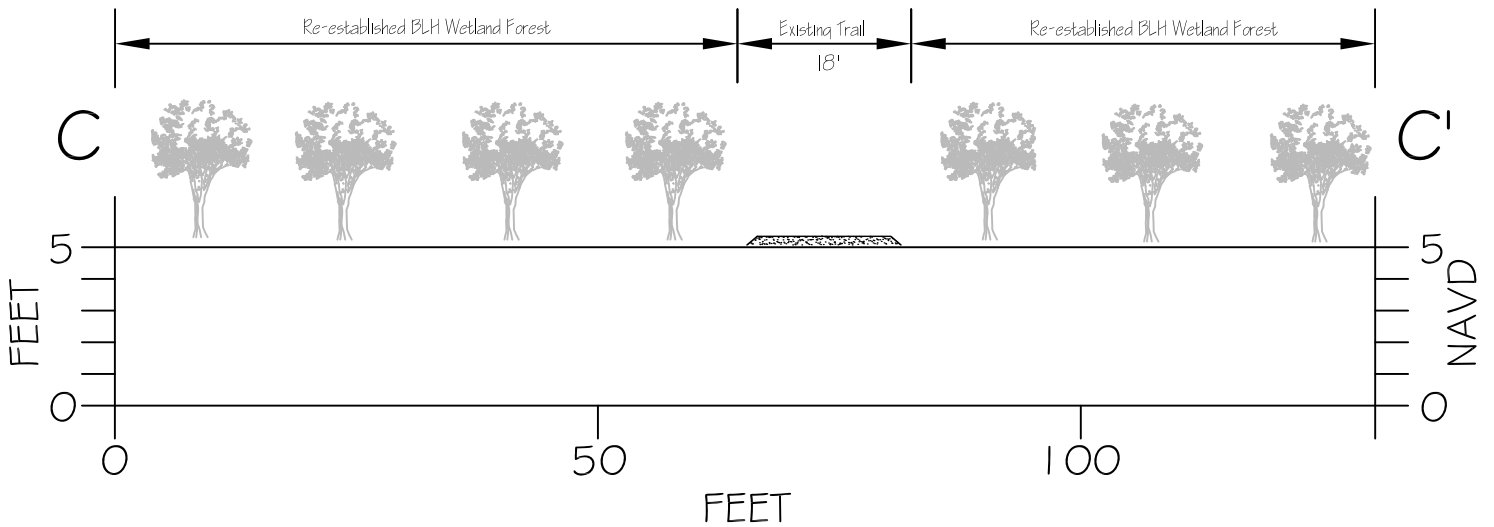

POST CONSTRUCTION SECTION

NTS
Vertically Exaggerated



-  Proposed Cut
-  Proposed Fill

Map Notes:

Elevations from LIDAR data & field observations



Delta Resource Mgmt LLC

Prairieville, LA
CROSS SECTIONS C - C'
MADEWOOD TRACT
ASSUMPTION PARISH, LA

Created: AGB

Approved: DT

Date: 07/31/2014

Map No.:

PRE-CONSTRUCTION SECTION

NTS
Vertically Exaggerated

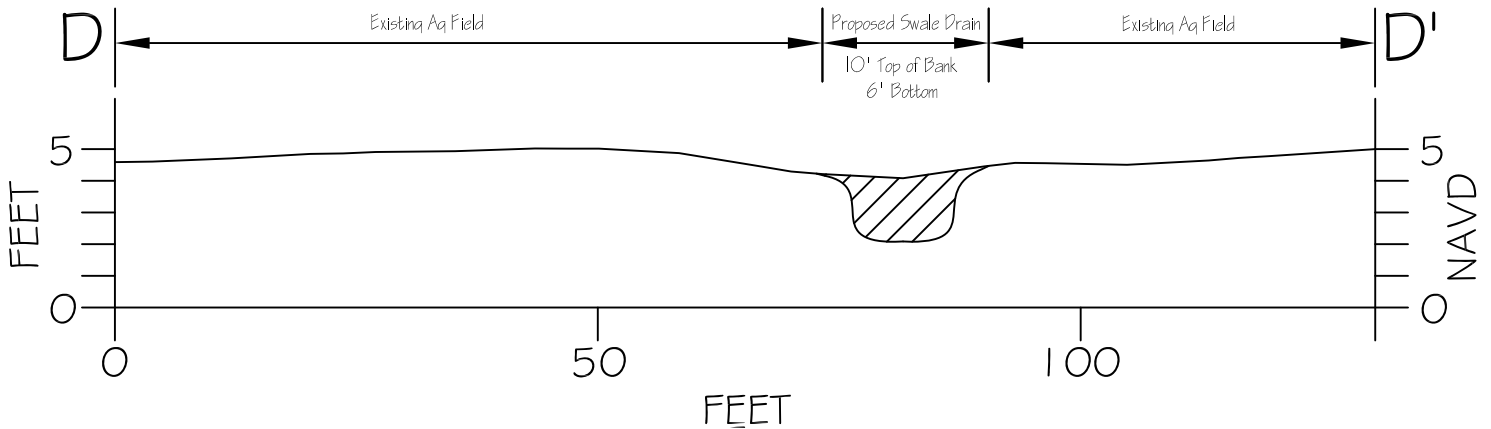

*Cut material deposited in ditches to be filled or in nonwetlands.

POST CONSTRUCTION SECTION

NTS
Vertically Exaggerated

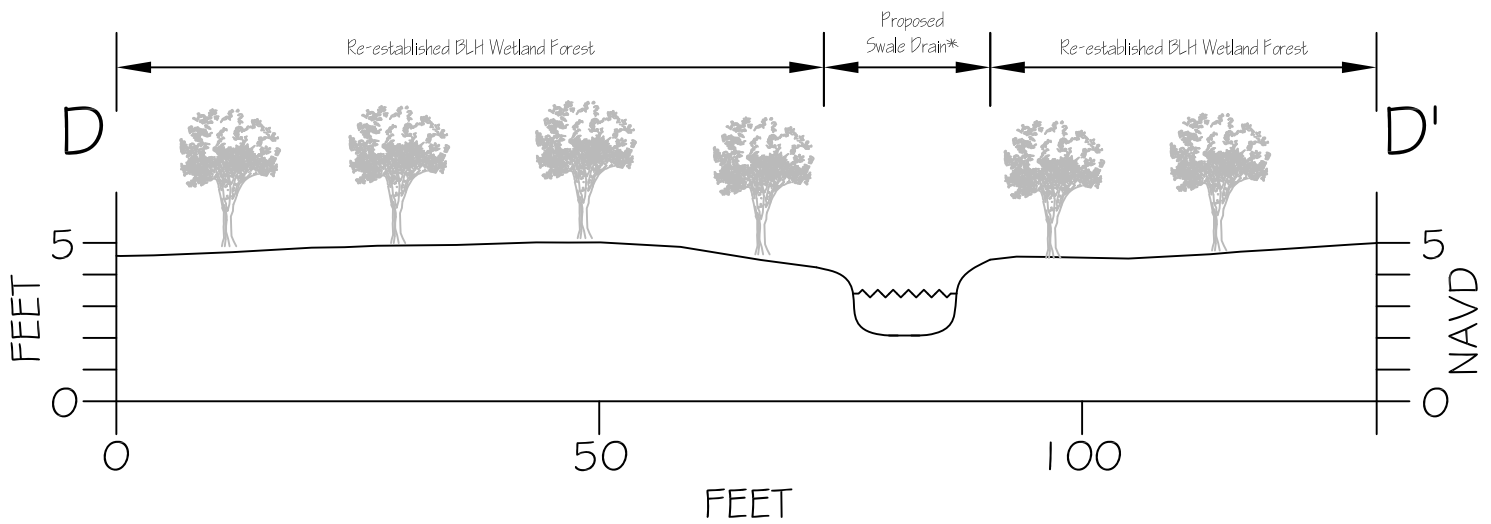

- Proposed Cut
- Proposed Fill

Map Notes:

Elevations from LIDAR data & field observations



Delta Resource Mgmt LLC

Prairieville, LA
CROSS SECTIONS D - D'
MADEWOOD TRACT
ASSUMPTION PARISH, LA

Created: AGB

Approved: DT

Date: 07/31/2014

Map No.:

PRE-CONSTRUCTION SECTION

NTS
Vertically Exaggerated

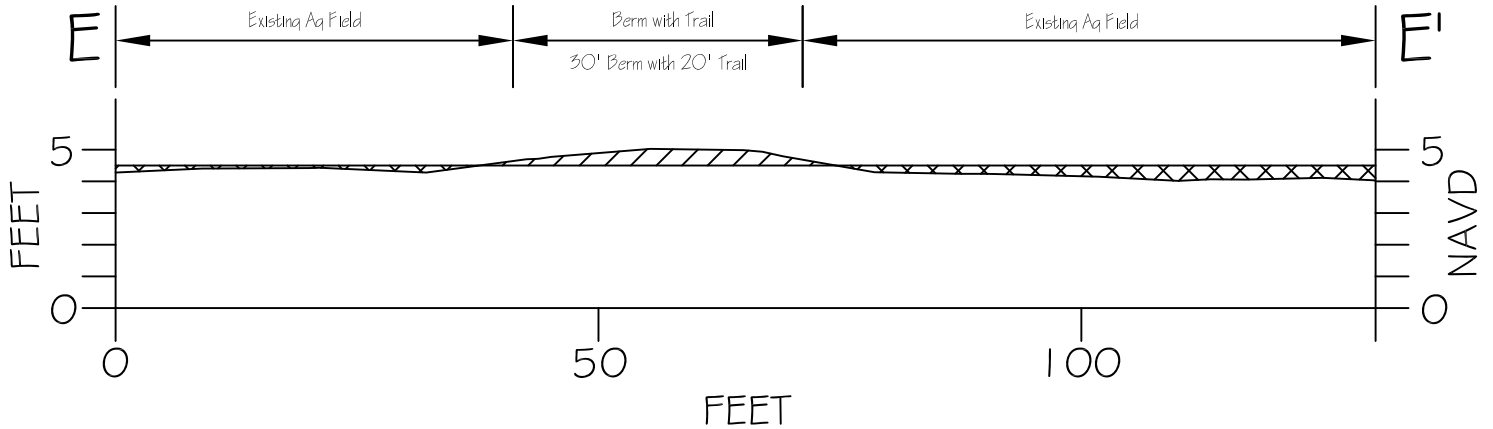

POST CONSTRUCTION SECTION

NTS
Vertically Exaggerated

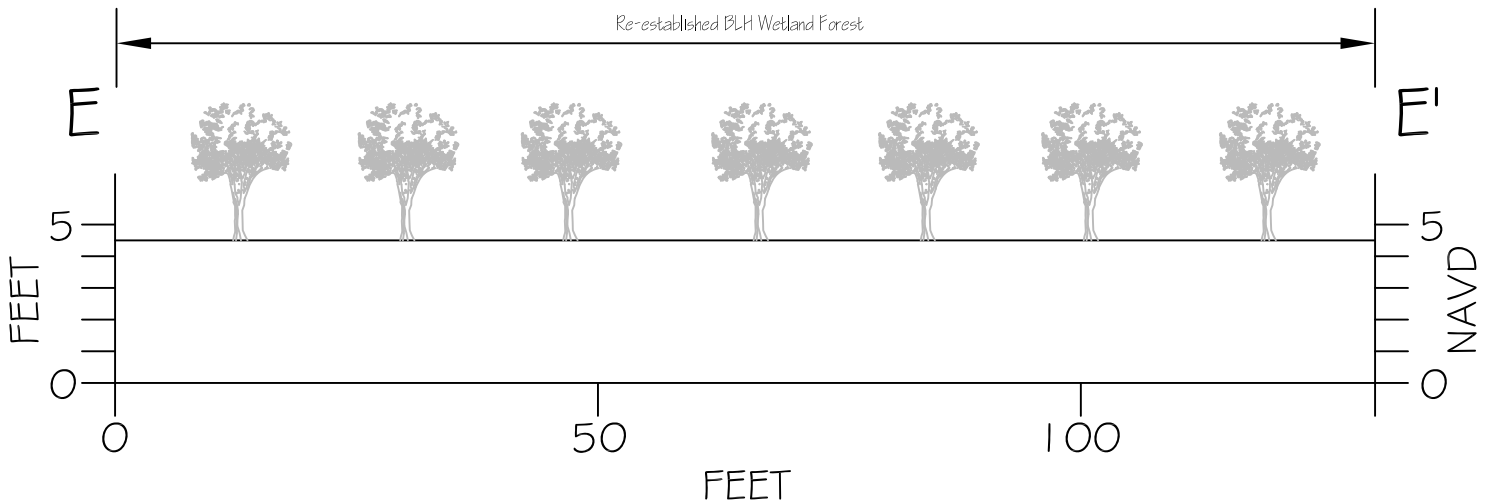

- Proposed Cut
- Proposed Fill

Map Notes:

Elevations from LIDAR data & field observations



Delta Resource Mgmt LLC

Prairieville, LA
CROSS SECTIONS E - E'
MADEWOOD TRACT
ASSUMPTION PARISH, LA

Created: AGB

Approved: DT

Date: 06/03/2014

Map No.:

PRE-CONSTRUCTION SECTION

NTS
Vertically Exaggerated

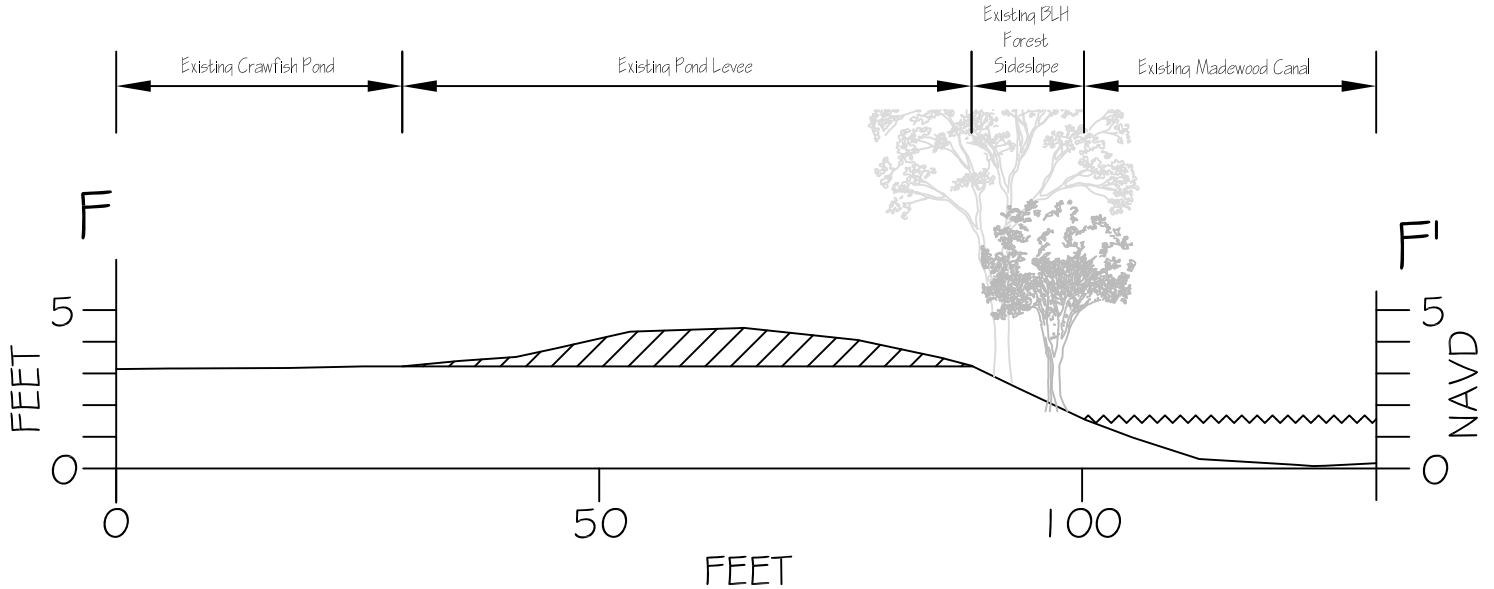



* Cut material deposited in ditches/ponds to be filled, in low-lying ag areas or in nonwetlands.

POST CONSTRUCTION SECTION

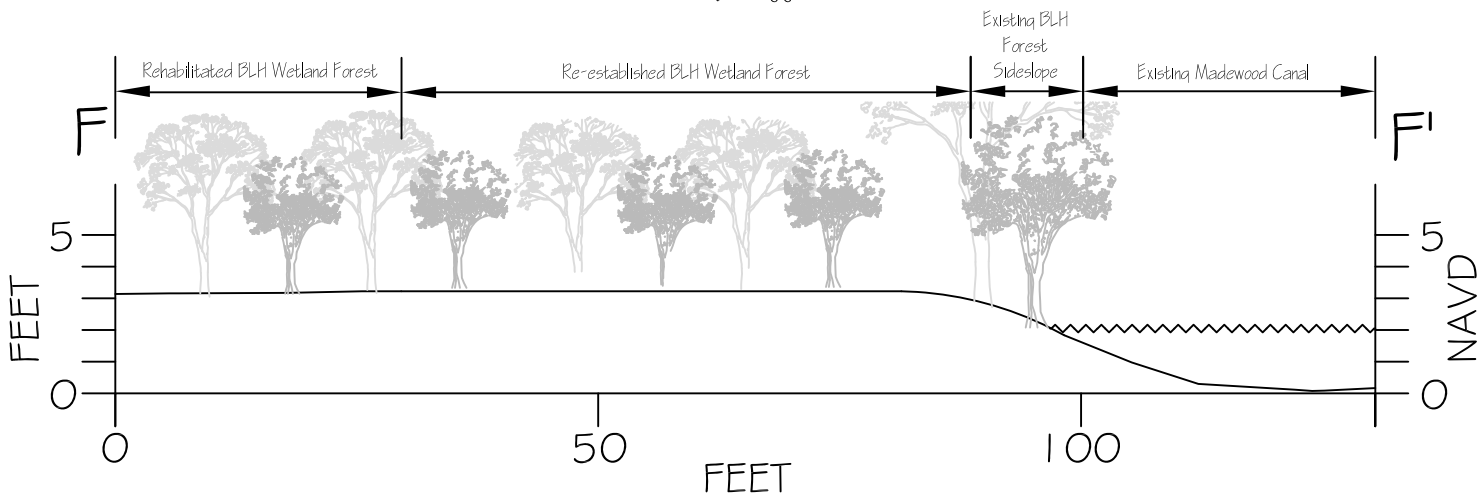
NTS
Vertically Exaggerated



-  Proposed Cut
-  Proposed Fill

*

Map Notes:

Elevations from LIDAR data & field observations



Delta Resource Mgmt LLC

Prairieville, LA
CROSS SECTIONS F - F'
MADEWOOD TRACT
ASSUMPTION PARISH, LA

Created: AGB

Approved: DT

Date: 07/31/2014

Map No.: